

Ice-O-Matic[®]

SERVICE PARTS MANUAL

ICE SERIES CUBERS

MODEL - ICE0250A5-T5-W5, ICE0400A4-T4-W4

MODEL - ICE0500A4-T4-W4-R5, ICE0606A4-T4-W4-R5

Includes 50Hz. Units



This parts list contains the service parts available for the ICE Series icemakers listed below:

ICE0250 A5, T5 and W5, Includes 50 hz. Models

ICE0400 A4, T4 and W4, Includes 50 hz. Models

ICE0500 A4, T4, W4 and R5

ICE0606 A4, T4, W4 and R5 Includes 50 hz. Models

Check the model number on the data plate and refer to the correct listing for the specific component.

Check carefully that the correct part is identified and ordered.

Table of Contents	Page 1
Cabinet Assembly	Page 2 - 3
Evaporator/Water System	Page 4 - 5
Air Cooled and Top Discharge	Page 6 - 7
Water Cooled	Page 8 - 9
Remote	Page 10 - 11
Control Box	Page 12 - 13
Specific Compressor Components	Page 13
Harvest Assist Assembly	Page 14 - 15
Remote Condenser	Page 16 - 17

The ICE Series Service Manual is available separately, Part number 9081270-01

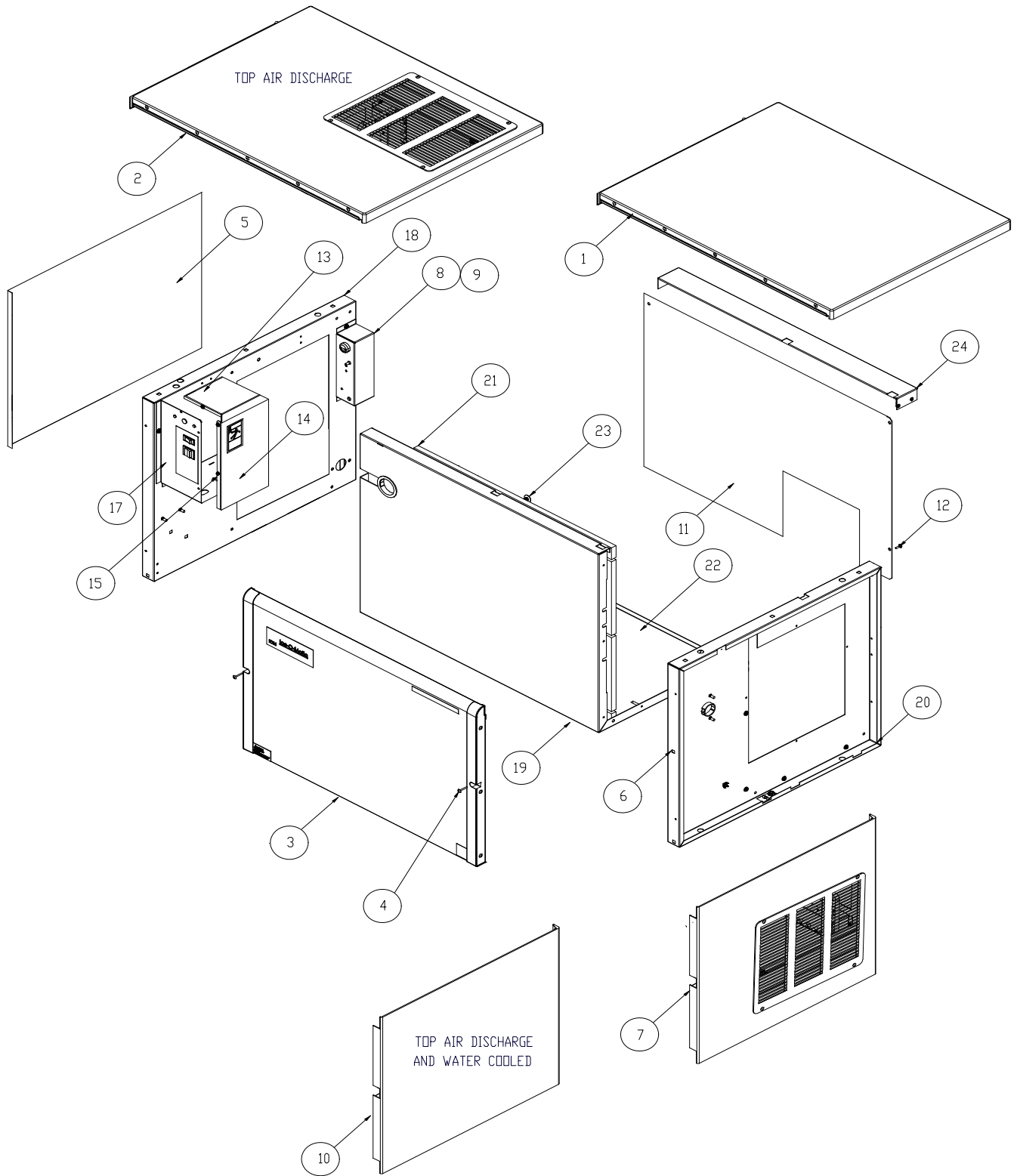

ICE Series Service Parts

Cabinet Assembly

Item No.	Model Number					Description
	ICE0250	ICE0400	ICE0406	ICE0500	ICE0606	
1	2101425-01S	2101425-01S	2101425-01S	2101425-01S	2101425-01S	Top Panel-Air Cooled
2	2101425-02S	2101425-02S	2101425-02S	2101425-02S	2101425-02S	Top Panel-Top Discharge
3	2031511-01S	2031511-01S	2031511-01S	2031511-01S	2031511-01S	Front Panel
	9051562-01	9051562-01	9051562-01	9051562-01	9051562-01	Front Panel End Cap, Right Hand
	9051562-02	9051562-02	9051562-02	9051562-02	9051562-02	Front Panel End Cap, Left Hand
4	9031098-04	9031098-04	9031098-04	9031098-04	9031098-04	Front Panel Screw
5	9051565-02	9051565-02	9051565-02	9051565-02	9051565-02	Left Hand Side Panel
6	9031141-01	9031141-01	9031141-01	9031141-01	9031141-01	Plastic Nut Insert
7	2101428-01S	2101428-01S	2101428-01S	2101428-01S	2101428-01S	Right Hand Side Panel-Louvered
8	3012681-01	3012681-01	3012681-01	3012681-01	3012681-01	Junction Box Cover
9	9031046-01	9031046-01	9031046-01	9031046-01	9031046-01	Junction Box Cover Screw
10	9051565-02	9051565-02	9051565-02	9051565-02	9051565-02	Right Hand Side Panel Non-Louvered
11	3021742-01	3021742-01	3021742-01	3021742-01	3021742-01	Rear Panel
12	9031046-01	9031046-01	9031046-01	9031046-01	9031046-01	Rear Panel Screw
13	3012905-01	3012905-01	3012905-01	3012905-01	3012905-01	Control Box Top Cover
14	3012904-01	3012904-01	3012904-01	3012904-01	3012904-01	Control Box Side Cover
15	9031046-01	9031046-01	9031046-01	9031046-01	9031046-01	Control Box Screws
16	N/A	N/A	N/A	N/A	N/A	Machine Compartment Cover (Not Shown)
17	3012855-01	3012855-01	3012855-01	3012855-01	3012855-01	Control Box Front Cover
18	2021677-01	2021677-01	2021677-01	2021677-01	2021677-01	Left Hand Frame Side
19	2021648-01	2021648-01	2021648-01	2021648-01	2021648-01	Divider Base Assembly
20	2021678-01	2021678-01	2021678-01	2021678-01	2021678-01	Right Hand Frame Side
21	9131181-01	9131181-01	9131181-01	9131181-01	9131181-01	Insulation
22	9131121-04	9131121-04	9131121-04	9131121-04	9131121-04	Insulation
23	9031154-01	9031154-01	9031154-01	9031154-01	9031154-01	Retainer "Christmas Tree Clip"
24	3012724-01	3012724-01	3012724-01	3012724-01	3012724-01	Brace

Item No.	Model Number			Description
	ICE0305	ICE0405	ICE0605	
1	2101425-01S	2101425-01S	2101425-01S	Top Panel-Air Cooled
2	2101425-02S	2101425-02S	2101425-02S	Top Panel-Top Discharge
3	2031511-01S	2031511-01S	2031511-01S	Front Panel
	9051562-01	9051562-01	9051562-01	Front Panel End Cap, Right Hand
	9051562-02	9051562-02	9051562-02	Front Panel End Cap, Left Hand
4	9031098-04	9031098-04	9031098-04	Front Panel Screw
5	9051565-02	9051565-02	9051565-02	Left Hand Side Panel
6	9031141-01	9031141-01	9031141-01	Plastic Nut Insert
7	2101428-01S	2101428-01S	2101428-01S	Right Hand Side Panel-Louvered
8	3012681-01	3012681-01	3012681-01	Junction Box Cover
9	9031046-01	9031046-01	9031046-01	Junction Box Cover Screw
10	9051565-02	9051565-02	9051565-02	Right Hand Side Panel Non-Louvered
11	3021742-01	3021742-01	3021742-01	Rear Panel
12	9031046-01	9031046-01	9031046-01	Rear Panel Screw
13	3012905-01	3012905-01	3012905-01	Control Box Top Cover
14	3012904-01	3012904-01	3012904-01	Control Box Side Cover
15	9031046-01	9031046-01	9031046-01	Control Box Screws
16	3012931-01	3012931-01	3012931-01	Machine Compartment Cover (Not Shown)
17	3012855-01	3012855-01	3012855-01	Control Box Front Cover
18	2021677-01	2021677-01	2021677-01	Left Hand Frame Side
19	2021648-01	2021648-01	2021648-01	Divider Base Assembly
20	2021678-01	2021678-01	2021678-01	Right Hand Frame Side
21	9131181-01	9131181-01	9131181-01	Insulation
22	9131121-04	9131121-04	9131121-04	Insulation
23	9031154-01	9031154-01	9031154-01	Retainer "Christmas Tree Clip"
24	3012724-01	3012724-01	3012724-01	Brace

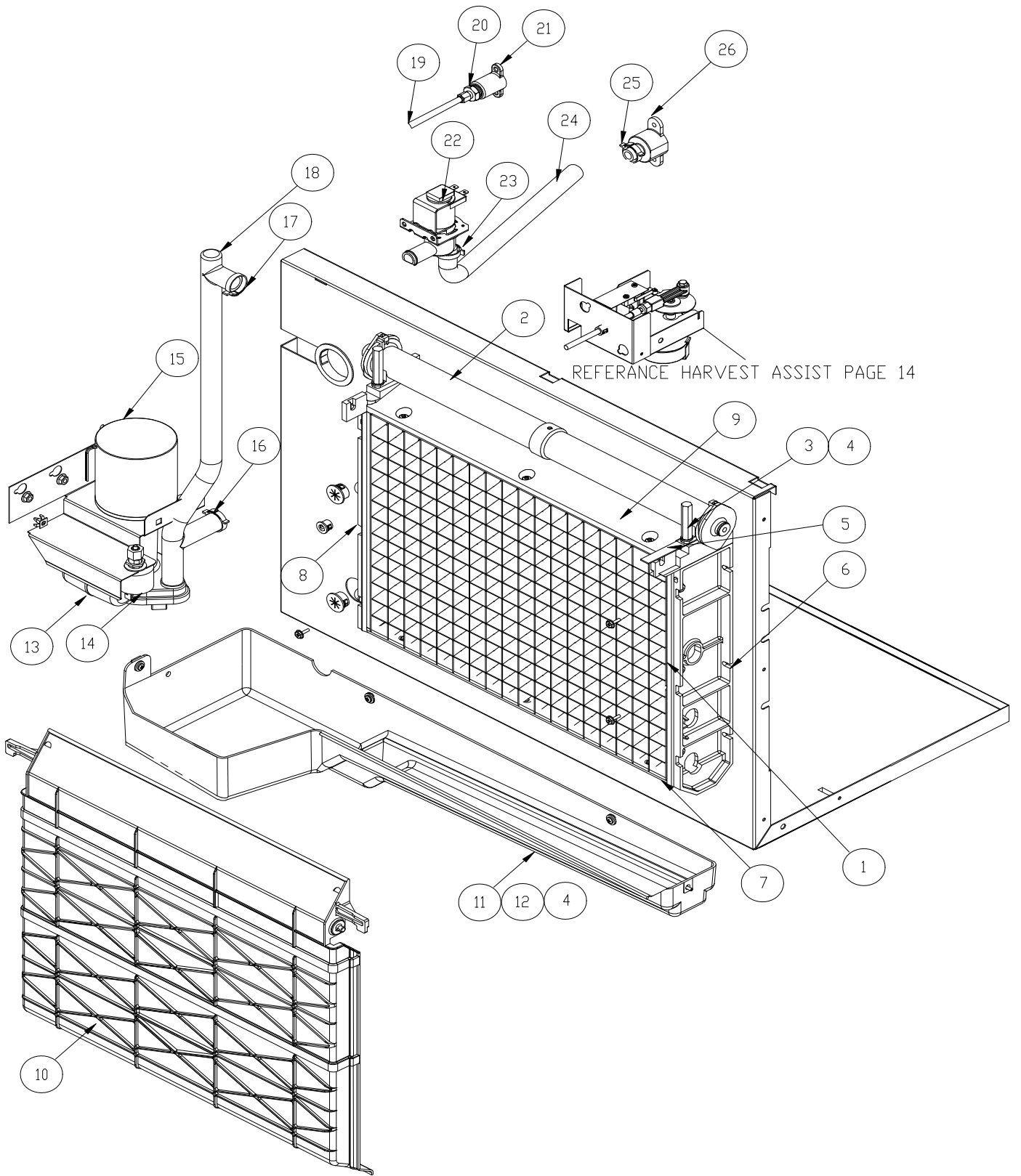

ICE Series Service Parts

Evaporator/Water System

Item No.	Model Number					Description
	ICE0250	ICE0400	ICE0406	ICE0500	ICE0606	
1	2051156-81	2051148-81	2051148-81	2051148-81	2051148-81	Evaporator Full Cube
1	2051156-82	2051148-82	2051148-82	2051148-82	2051148-82	Evaporator Half Cube
2	2041338-01	2041338-01	2041338-01	2041338-01	2041338-01	Water Distribution Tube
3	9031122-05	9031122-05	9031122-05	9031122-05	9031122-05	Thumb Screw
4	9031004-19	9031004-19	9031004-19	9031004-19	9031004-19	Rubber Washer
5	3012747-01	N/A	N/A	N/A	N/A	Curtain Stopper
6	9051136-08	9051136-06	9051136-06	9051136-06	9051136-06	Evaporator Mounting Panel Right Side
7	9051135-04	9051135-04	9051135-04	9051135-04	9051135-04	Evaporator Water Return
8	9051136-07	9051136-05	9051136-05	9051136-05	9051136-05	Evaporator Mounting Panel Left Side
9	9051135-05	9051135-05	9051135-05	9051135-05	9051135-05	Evaporator Spillway
10	9051154-07	9051154-08	9051154-08	9051154-08	9051154-08	Evaporator Splash Curtain
11	9051537-01	9051537-01	9051537-01	9051537-01	9051537-01	Water Return Trough
12	9031046-24	9031046-24	9031046-24	9031046-24	9031046-24	Water Return Trough Screw
13	9131111-01	9131111-01	9131111-01	9131111-01	9131111-01	Float
14	9131026-02	9131026-02	9131026-02	9131026-02	9131026-02	Caplug (Float Deflector)
15	9161076-01	9161076-01	9161076-01	9161076-01	9161076-01	Water Pump
	3012509-01	3012509-01	3012509-01	3012509-01	3012509-01	Water Pump Bracket
16	9021010-04	9021010-04	9021010-04	9021010-04	9021010-04	Clamp
17	9021010-04	9021010-04	9021010-04	9021010-04	9021010-04	Clamp
18	9051142-02	9051142-01	9051142-01	9051142-01	9051142-01	Water Pump Tube
19	3032898-26	3032898-26	3032898-26	3032898-26	3032898-26	Water Float Tubing (26 Inches required)
20	9091083-01	9091083-01	9091083-01	9091083-01	9091083-01	Water Inlet Fitting
21	9091074-01	9091074-01	9091074-01	9091074-01	9091074-01	Drop Adapter
22	9041086-01	9041086-01	9041086-02	9041086-01	9041086-02	Purge Valve
23	9021010-04	9021010-04	9021010-04	9021010-04	9021010-04	Clamp
24	9051280-11	9051280-11	9051280-11	9051280-11	9051280-11	Purge Drain Hose
25	9021010-03	9021010-03	9021010-03	9021010-03	9021010-03	Clamp
26	9091140-01	9091140-01	9091140-01	9091140-01	9091140-01	Purge Drain Fitting

Item No.	Model Number - 50 Cycle Units			Description
	ICE0305	ICE0405	ICE0605	
1	2051156-81	2051148-81	2051148-81	Evaporator Full Cube
1	2051156-82	2051148-82	2051148-82	Evaporator Half Cube
2	2041338-01	2041338-01	2041338-01	Water Distribution Tube
3	9031122-05	9031122-05	9031122-05	Thumb Screw
4	9031004-19	9031004-19	9031004-19	Rubber Washer
5	3012747-01	N/A	N/A	Curtain Stopper
6	9051136-08	9051136-06	9051136-06	Evaporator Mounting Panel Right Side
7	9051135-04	9051135-04	9051135-04	Evaporator Water Return
8	9051136-07	9051136-05	9051136-05	Evaporator Mounting Panel Left Side
9	9051135-05	9051135-05	9051135-05	Evaporator Spillway
10	9051154-07	9051154-08	9051154-08	Evaporator Splash Curtain
11	9051537-01	9051537-01	9051537-01	Water Return Trough
12	9031046-24	9031046-24	9031046-24	Water Return Trough Screw
13	9131111-01	9131111-01	9131111-01	Float
14	9131026-02	9131026-02	9131026-02	Caplug (Float Deflector)
15	9161076-02	9161076-02	9161076-02	Water Pump (for bracket see above)
16	9021010-04	9021010-04	9021010-04	Clamp
17	9021010-04	9021010-04	9021010-04	Clamp
18	9051142-02	9051142-01	9051142-01	Water Pump Tube
19	3032898-26	3032898-26	3032898-26	Water Float Tubing (26 Inches required)
20	9091083-01	9091083-01	9091083-01	Water Inlet Fitting
21	9091074-01	9091074-01	9091074-01	Drop Adapter
22	9041086-02	9041086-02	9041086-02	Purge Valve
23	9021010-04	9021010-04	9021010-04	Clamp
24	9051280-11	9051280-11	9051280-11	Purge Drain Hose
25	9021010-03	9021010-03	9021010-03	Clamp
26	9091140-01	9091140-01	9091140-01	Purge Drain Fitting

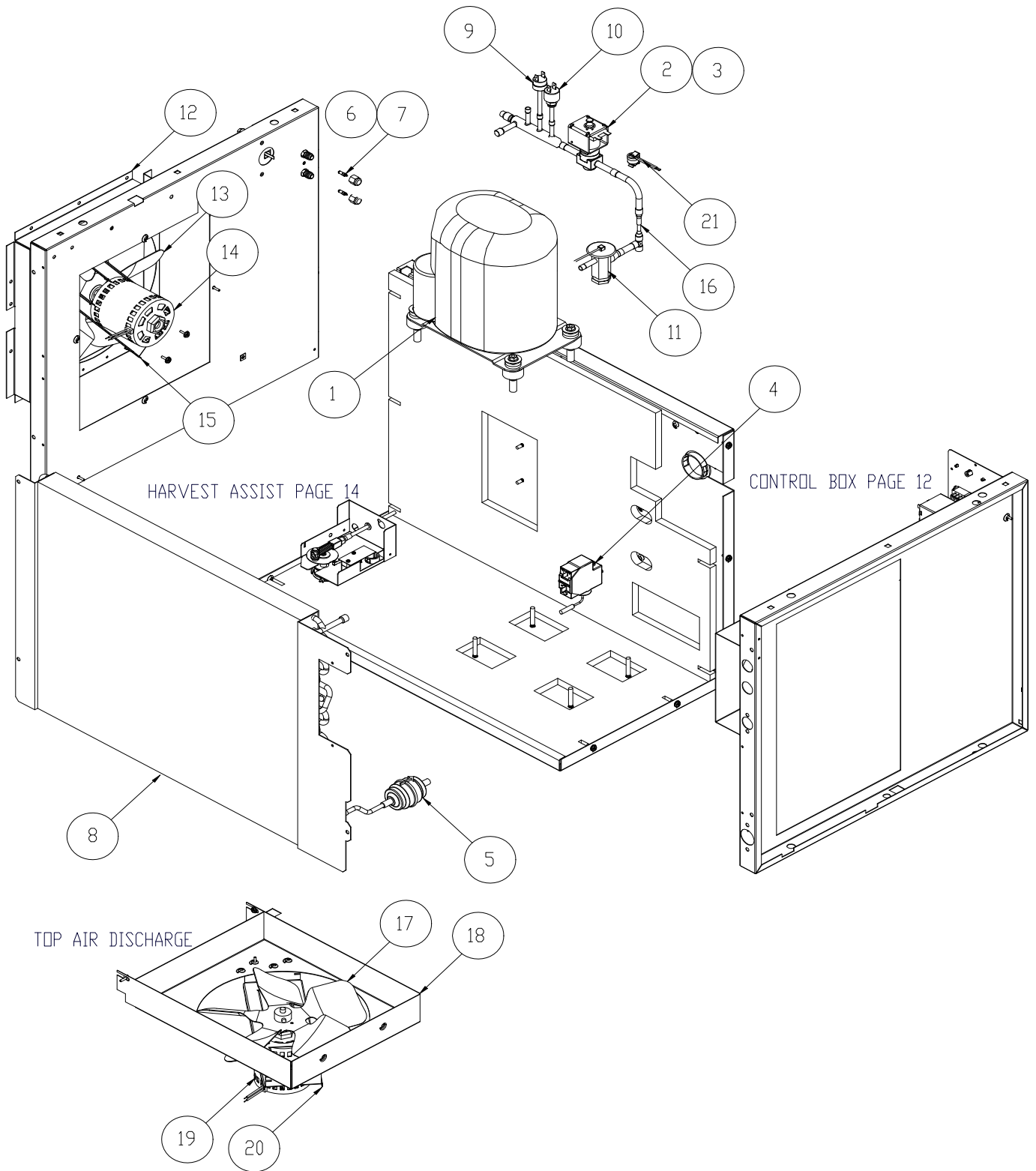

Item No.	Model Number					Description
	ICE0250A	ICE0400A	ICE0406A	ICE0500A	ICE0606A	
1	9181121-11	9181121-11	9181126-01	9181124-11	9181125-11	Compressor Kit
2	9151123-01	9151123-01	9151123-01	9151123-01	9151123-01	Hot Gas Valve Body
3	9151123-03	9151123-03	9151123-04	9151123-03	9151123-04	Hot Gas Valve Coil
4	9041094-01	9041094-01	9041094-01	9041094-01	9041094-01	Low Pressure Control
5	9151004-02	9151004-02	9151004-02	9151004-02	9151004-02	Filter Drier
6	9091086-02	9091086-02	9091086-02	9091086-02	9091086-02	Service Valve Core
7	9091086-03	9091086-03	9091086-03	9091086-03	9091086-03	Service Valve Cap
8	9141106-01	9141106-01	9141106-01	9141120-01	9141120-01	Condenser
9	9041096-01	9041096-01	9041096-01	9041096-01	9041096-01	Fan Control
10	9041091-01	9041091-01	9041091-01	9041091-01	9041091-01	High Pressure Control
11	9151154-01	9151149-01	9151149-01	9151149-01	9151151-01	Expansion Valve
	9131465-01	9131465-01	9131465-01	9131465-01	9131465-01	Insulation-Danfoss Expansion Valve
12	3013112-01	3013112-01	3013112-01	3013112-01	3013112-01	Fan Shroud
13	9131332-02	9131332-02	9131332-02	9131383-01	9131332-02	Fan Blade
14	9161089-02	9161089-02	9161089-03	9161078-01	9161089-03	Fan Motor
15	3012527-01	3012527-01	3012527-01	3013252-01	3012527-01	Fan Motor Bracket
16	9091136-01	9091136-01	9091136-01	9091136-01	N/A	Restrictor
17	9131383-01	9131332-02	9131332-02	9131383-01	9131332-02	Fan Blade (Top Air Discharge)
18	3012725-01	3012725-01	3012725-01	3012725-01	3012725-01	Fan Shroud (Top Air Discharge)
19	9161078-01	9161089-02	9161089-03	9161078-01	9161089-03	Fan Motor (Top Air Discharge)
20	3013252-01	3012527-01	3012527-01	3013252-01	3012527-01	Fan Motor Bracket (Top Air Discharge)
21	9041098-01	9041098-01	9041098-01	9041098-01	9041098-01	High Temperature Safety Control
						Top Air Discharge Conversion Kit

Item No.	Model Number			Description
	ICE0305A	ICE0405A	ICE0605A	
1	9181127-11	9181127-11	9181128-11	Compressor Kit
2	9151123-01	9151123-01	9151123-01	Hot Gas Valve Body
3	9151123-04	9151123-04	9151123-04	Hot Gas Valve Coil
4	9041094-01	9041094-01	9041094-01	Low Pressure Control
5	9151004-02	9151004-02	9151004-02	Filter Drier
6	9091086-02	9091086-02	9091086-02	Service Valve Core
7	9091086-03	9091086-03	9091086-03	Service Valve Cap
8	9141106-01	9141106-01	9141120-01	Condenser
9	9041096-01	9041096-01	9041096-01	Fan Control
10	9041091-01	9041091-01	9041091-01	High Pressure Control
11	9151154-01	9151149-01	9151149-01	Expansion Valve
	9131465-01	9131465-01	9131465-01	Insulation-Danfoss Expansion Valve
12	3013112-01	3013112-01	3013112-01	Fan Shroud
13	9131383-01	9131383-01	9131383-01	Fan Blade
14	9161078-02	9161078-02	9161078-02	Fan Motor
15	2021612-01	2021612-01	2021612-01	Fan Motor Bracket
16	N/A	9091136-01	N/A	Restrictor
17	N/A	N/A	N/A	Fan Blade (Top Air Discharge)
18	N/A	N/A	N/A	Fan Shroud (Top Air Discharge)
19	N/A	N/A	N/A	Fan Motor (Top Air Discharge)
20	N/A	N/A	N/A	Fan Motor Bracket (Top Air Discharge)
21	9041098-01	9041098-01	9041098-01	High Temperature Safety Control
				Top Air Discharge Conversion Kit

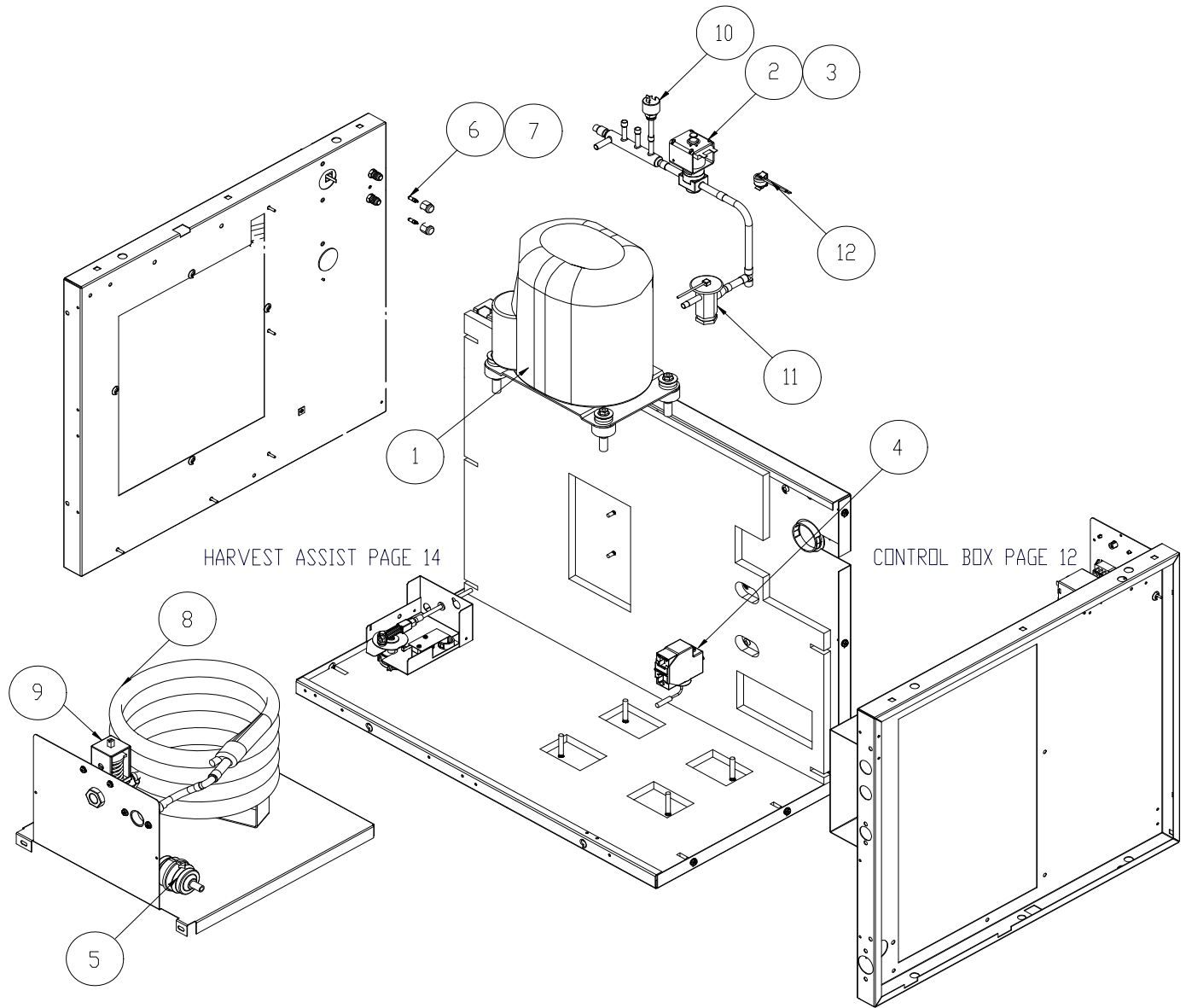

Item No.	Model Number					Description
	ICE0250W	ICE0400W	ICE0406W	ICE0500W	ICE0606W	
1	9181121-11	9181121-11	9181126-11	9181124-11	9181125-11	Compressor
2	9151123-01	9151123-01	9151123-01	9151123-01	9151123-01	Hot Gas Valve Body
3	9151023-03	9151023-03	9151123-04	9151023-03	9151123-04	Hot Gas Valve Coil
4	9041094-01	9041094-01	9041094-01	9041094-01	9041094-01	Low Pressure Control
5	9151004-02	9151004-02	9151004-02	9151004-02	9151004-02	Filter Drier
6	9091086-02	9091086-02	9091086-02	9091086-02	9091086-02	Service Valve Core
7	9091086-03	9091086-03	9091086-03	9091086-03	9091086-03	Service Valve Cap
8	9141061-01	9141023-01	9141023-01	9141024-01	9141024-01	Condenser
9	9041059-01	9041059-01	9041059-01	9041059-01	9041059-01	Water Valve
10	9041091-01	9041091-01	9041091-01	9041091-01	9041091-01	High Pressure Control
11	9151154-01	9151149-01	9151149-01	9151149-01	9151151-01	Expansion Valve
	9131465-01	9131465-01	9131465-01	9131465-01	9131465-01	Insulation-Danfoss Expansion Valve
12	9041098-01	9041098-01	9041098-01	9041098-01	9041098-01	High Temperature Safety Control

Item No.	Model Number			Description
	ICE0305W	ICE0405W	ICE0605W	
1	9181127-11	9181127-11	9181128-11	Compressor
2	9151123-01	9151123-01	9151123-01	Hot Gas Valve Body
3	9151123-04	9151123-04	9151123-04	Hot Gas Valve Coil
4	9041094-01	9041094-01	9041094-01	Low Pressure Control
5	9151004-02	9151004-02	9151004-02	Filter Drier
6	9091086-02	9091086-02	9091086-02	Service Valve Core
7	9091086-03	9091086-03	9091086-03	Service Valve Cap
8	9141061-01	9141023-01	9141024-01	Condenser
9	9041059-01	9041059-01	9041059-01	Water Valve
10	9041091-01	9041091-01	9041091-01	High Pressure Control
11	9151154-01	9151149-01	9151149-01	Expansion Valve
	9131465-01	9131465-01	9131465-01	Insulation-Danfoss Expansion Valve
12	9041098-01	9041098-01	9041098-01	High Temperature Safety Control

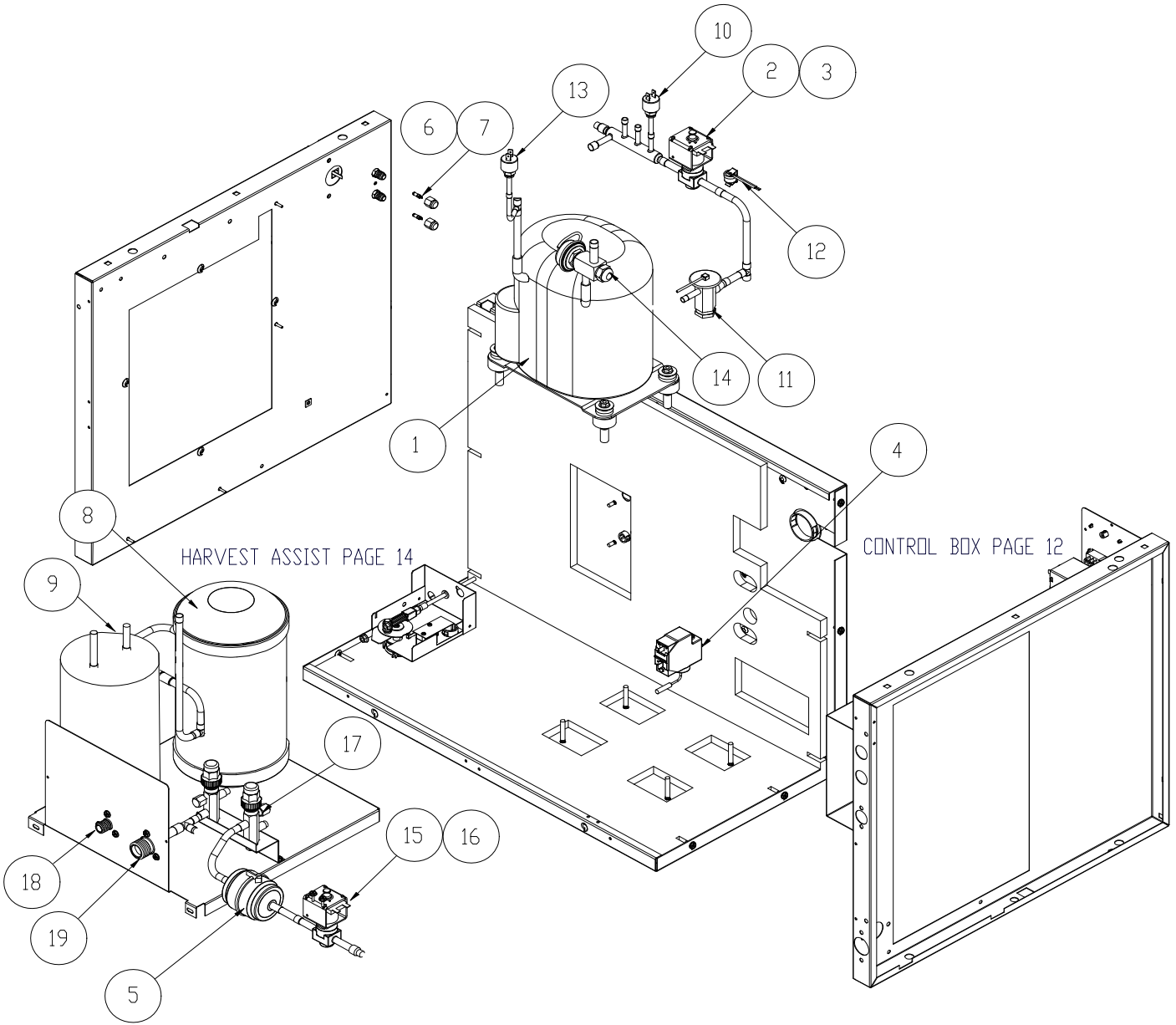

Item No.	Model Number					Description
	ICE0250	ICE0400	ICE0406	ICE0500R	ICE0606R	
1	N/A	N/A	N/A	9181124-11	9181125-11	Compressor
2	N/A	N/A	N/A	9151123-01	9151123-01	Hot Gas Valve Body
3	N/A	N/A	N/A	9151123-03	9151123-04	Hot Gas Valve Coil
4	N/A	N/A	N/A	9041094-01	9041094-01	Low Pressure Control
5	N/A	N/A	N/A	9151004-04	9151004-04	Filter Drier
6	N/A	N/A	N/A	9091086-02	9091086-02	Service Valve Core
7	N/A	N/A	N/A	9091086-03	9091086-03	Service Valve Cap
8	N/A	N/A	N/A	9151074-01	9151074-01	Receiver
9	N/A	N/A	N/A	2091204-01	N/A	Accumulator
10	N/A	N/A	N/A	9041091-01	9041091-01	High Pressure Control
11	N/A	N/A	N/A	9151149-01	9151151-01	Expansion Valve
	N/A	N/A	N/A	9131465-01	9131465-01	Insulation Danfoss Expansion Valve
12	N/A	N/A	N/A	9041098-01	9041098-01	High Temperature Safety Control
13	N/A	N/A	N/A	9041092-02	9041092-02	Pump Down Control
14	N/A	N/A	N/A	9151086-01	N/A	Crankcase Pressure Regulator
15	N/A	N/A	N/A	9151123-02	9151123-02	Liquid Line Solenoid Body
16	N/A	N/A	N/A	9151123-03	9151123-04	Liquid Line Solenoid Coil
17	N/A	N/A	N/A	9091137-01	9091137-01	Valve-Shut Off
18	N/A	N/A	N/A	9091001-11	9091001-11	Remote Fitting 3/8 Male
19	N/A	N/A	N/A	9091001-12	9091001-12	Remote Fitting 1/2 Male
20	N/A	N/A	N/A	9151139-01	9151139-01	Check Valve

Item No.	Model Number			Description
	ICE0305	ICE0405	ICE0605R	
1	N/A	N/A	9181128-11	Compressor
2	N/A	N/A	9151123-01	Hot Gas Valve Body
3	N/A	N/A	9151123-04	Hot Gas Valve Coil
4	N/A	N/A	9041094-01	Low Pressure Control
5	N/A	N/A	9151004-04	Filter Drier
6	N/A	N/A	9091086-02	Service Valve Core
7	N/A	N/A	9091086-03	Service Valve Cap
8	N/A	N/A	9151074-01	Receiver
9	N/A	N/A	N/A	Accumulator
10	N/A	N/A	9041091-01	High Pressure Control
11	N/A	N/A	9151149-01	Expansion Valve
	N/A	N/A	9131465-01	Insulation Danfoss Expansion Valve
12	N/A	N/A	9041098-01	High Temperature Safety Control
13	N/A	N/A	9041092-02	Pump Down Control
14	N/A	N/A	N/A	Crankcase Pressure Regulator
15	N/A	N/A	9151123-02	Liquid Line Solenoid Body
16	N/A	N/A	9151123-04	Liquid Line Solenoid Coil
17	N/A	N/A	9091137-01	Valve-Shut Off
18	N/A	N/A	9091001-11	Remote Fitting 3/8 Male
19	N/A	N/A	9091001-12	Remote Fitting 1/2 Male
20	N/A	N/A	9151139-01	Check Valve

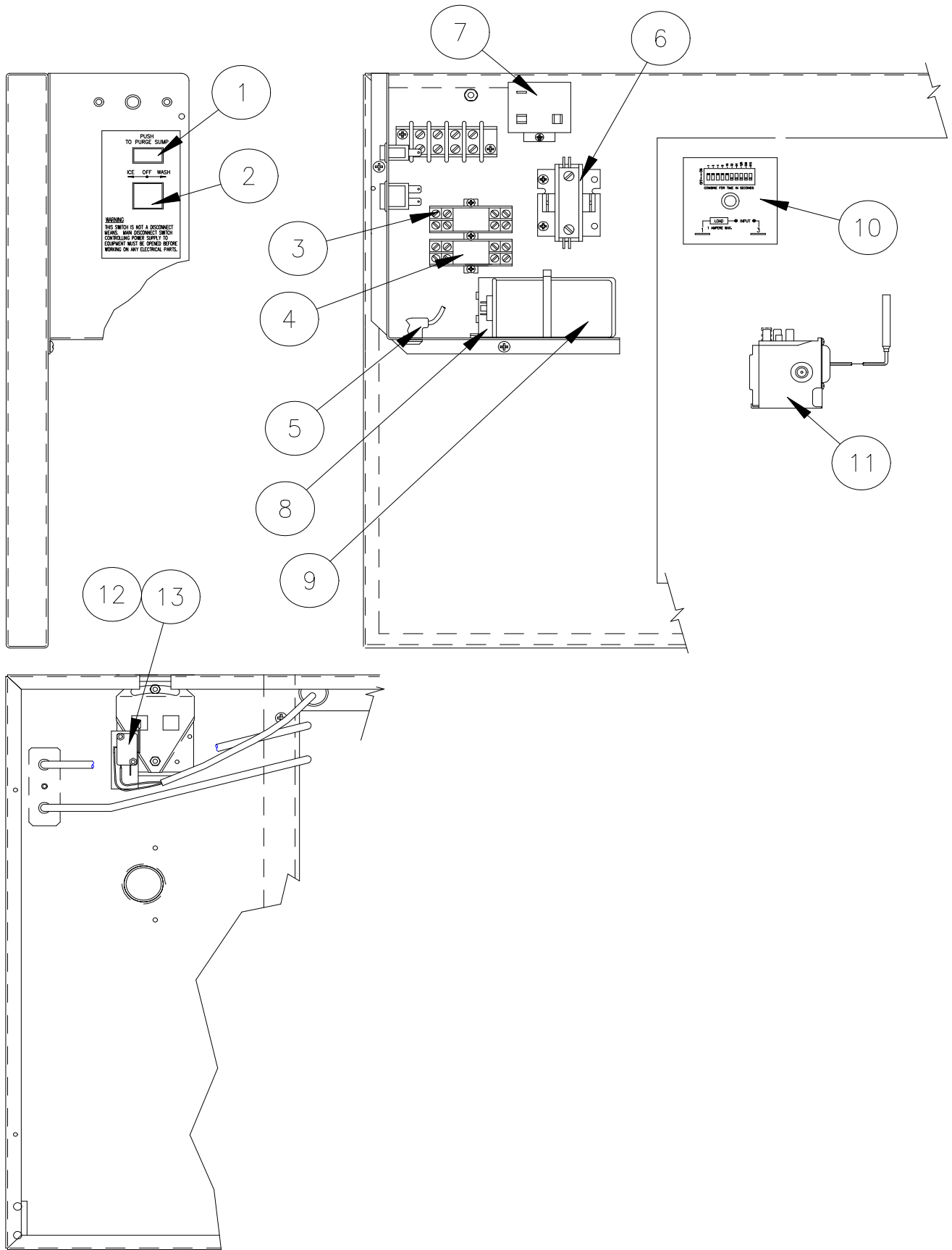

Item No.	Model Number					Description
	ICE0250	ICE0400	ICE0406	ICE0500	ICE0606	
1	9101139-03	9101139-03	9101139-03	9101139-03	9101139-03	Purge Switch
2	9101195-01	9101195-01	9101195-01	9101195-01	9101195-01	ON-OFF-WASH Switch
3	9101083-01	9101083-01	9101083-01	9101083-01	9101083-01	Relay Socket
4	9101084-01	9101084-01	9101084-02	9101084-01	9101084-02	Relay
5	9101218-12	9101218-12	9101218-12	9101218-12	9101218-12	Water Pump Cord
6	9101002-07	9101002-03	9101002-04	9101002-03	9101002-04	Contactora
7	9181004-27	9181010-14	9181004-07	9181010-12	9181010-10	Compressor Start Relay
8	9181003-39	9181003-39	9181003-45	9181003-40	9181003-19	Start Capacitor
9	N/A	N/A	9181009-08	9181009-11	9181009-16	Run Capacitor
10	9101148-01	9101148-01	9101148-01	9101148-01	9101148-01	Timer
11	9041094-01	9041094-01	9041094-01	9041094-01	9041094-01	Low Pressure Timer Initiate
12	2061471-03	2061471-03	2061471-03	2061471-03	2061471-03	Curtain Switch Assembly
13	9101124-02	9101124-02	9101124-02	9101124-02	9101124-02	Curtain Switch

Item No.	Model Number			Description
	ICE0305	ICE0405	ICE0605	
1	9101139-03	9101139-03	9101139-03	Purge Switch
2	9101195-01	9101195-01	9101195-01	ON-OFF-WASH Switch
3	9101083-01	9101083-01	9101083-01	Relay Socket
4	9101084-02	9101084-02	9101084-02	Relay
5	9101218-12	9101218-12	9101218-12	Water Pump Cord
6	9101002-04	9101002-04	9101002-04	Contactora
7	9181004-04	9181004-04	9181010-10	Compressor Start Relay
8	9181003-45	9181003-45	9181003-44	Start Capacitor
9	N/A	N/A	9181009-17	Run Capacitor
10	9101148-01	9101148-01	9101148-01	Timer
11	9041094-01	9041094-01	9041094-01	Low Pressure Timer Initiate
12	2061471-03	2061471-03	2061471-03	Curtain Switch Assembly
13	9101124-02	9101124-02	9101124-02	Curtain Switch

Compressor Components

Model Number					Description
ICE0250	ICE0400	ICE0406	ICE0500	ICE0606	
9181121-01	9181121-01	9181126-01	9181124-01	9181125-01	Compressor
9181005-37	9181005-37	9181005-44	9181005-43	Internal	Overload
9181004-27	9181004-27	9181010-29	9181010-28	9181010-10	Relay
9181003-39	9181003-39	9181003-45	9181003-40	9181003-19	Start Capacitor
N/A	N/A	9181009-08	9181009-11	9181009-16	Run Capacitor

Model Number			Description
ICE0305	ICE0405	ICE0605	
9181127-01	9181127-01	9181128-01	Compressor
9181005-44	9181005-44	Internal	Overload
9181010-30	9181010-30	9181010-10	Relay
9181003-45	9181003-45	9181003-44	Start Capacitor
9181009-08	9181009-08	9181009-17	Run Capacitor

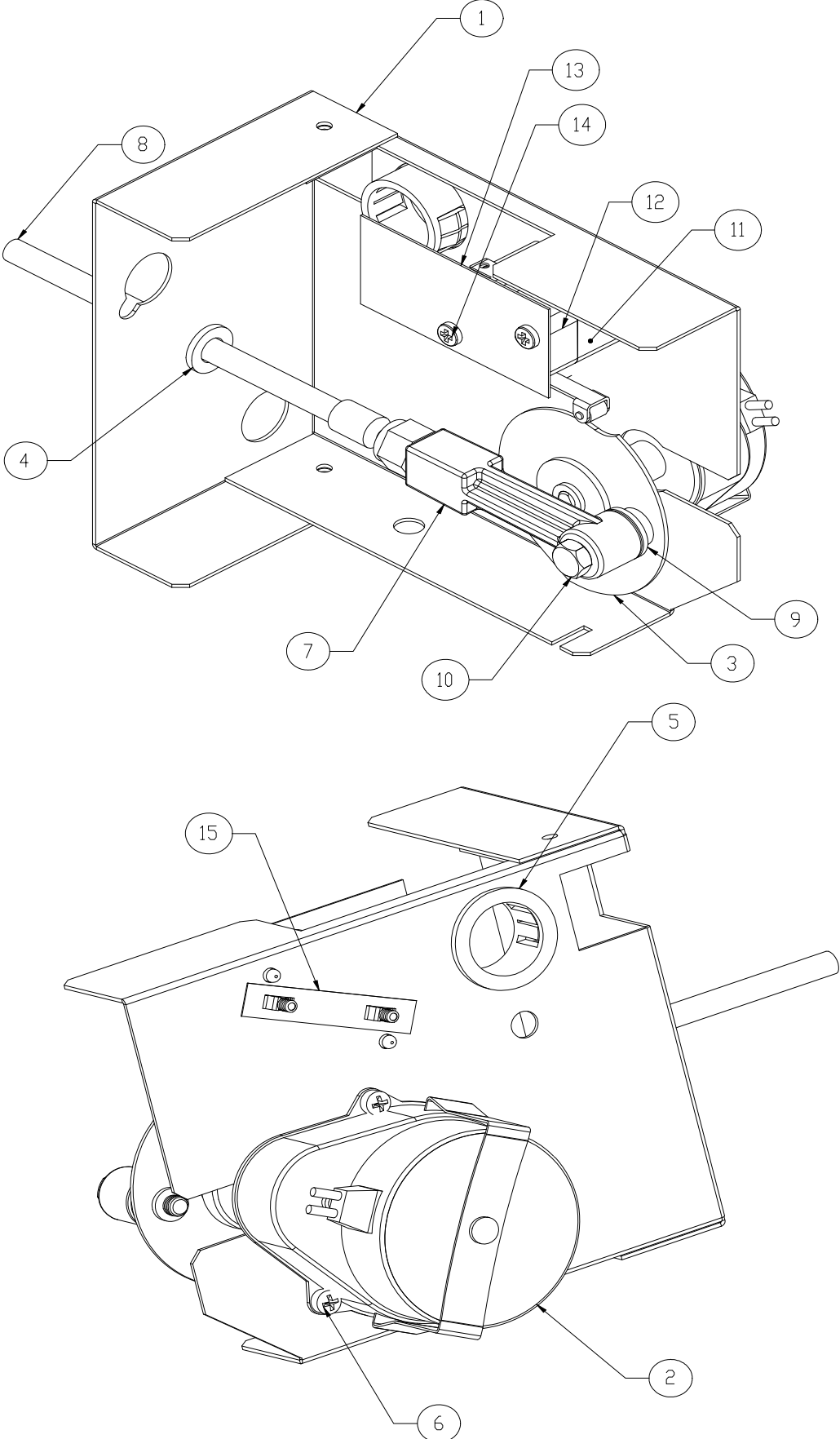

ICE Series Service Parts

Harvest Assist Assembly

Item No.	Model Number					Description
	ICE0250	ICE0400	ICE0406	ICE0500	ICE0606	
1	3013170-01	3013170-01	3013170-01	3013170-01	3013170-01	Bracket, Probe Motor
2	9161030-01	9161030-01	9161031-01	9161030-01	9161031-01	Gear Motor
3	9131190-01	9131190-01	9131190-01	9131190-01	9131190-01	Clutch Assembly 180 Degree
4	9051001-13	9051001-13	9051001-13	9051001-13	9051001-13	Snap Bushing
5	9051001-03	9051001-03	9051001-03	9051001-03	9051001-03	Snap Bushing
6	9031019-08	9031019-08	9031019-08	9031019-08	9031019-08	#6-32 x 1/2 Fillister Head Screw
7	9051057-01	9051057-01	9051057-01	9051057-01	9051057-01	Connecting Rod
8	9021102-01	9021102-01	9021102-01	9021102-01	9021102-01	Probe, Single Length
9	9031003-03	9031003-03	9031003-03	9031003-03	9031003-03	Plain Flat Washer
10	9031119-01	9031119-01	9031119-01	9031119-01	9031119-01	Shoulder Screw
11	9051519-01	9051519-01	9051519-01	9051519-01	9051519-01	Spacer, Cam Switch
12	9101160-01	9101160-01	9101160-01	9101160-01	9101160-01	Cam Switch
13	3051145-02	3051145-02	3051145-02	3051145-02	3051145-02	Insulator, Switch
14	9031008-44	9031008-44	9031008-44	9031008-44	9031008-44	Pan Head Machine Screw
15	9031120-01	9031120-01	9031120-01	9031120-01	9031120-01	Speed Nut Plate
	2061962-01S	2061962-01S	2061962-02S	2061962-01S	2061962-02S	Complete Assembly

Item No.	Model Number			Description
	ICE0305	ICE0405	ICE0605	
1	3013170-01	3013170-01	3013170-01	Bracket, Probe Motor
2	9161031-01	9161031-01	9161031-01	Gear Motor
3	9131190-01	9131190-01	9131190-01	Clutch Assembly 180 Degree
4	9051001-13	9051001-13	9051001-13	Snap Bushing
5	9051001-03	9051001-03	9051001-03	Snap Bushing
6	9031019-08	9031019-08	9031019-08	#6-32 x 1/2 Fillister Head Screw
7	9051057-01	9051057-01	9051057-01	Connecting Rod
8	9021102-01	9021102-01	9021102-01	Probe, Single Length
9	9031003-03	9031003-03	9031003-03	Plain Flat Washer
10	9031119-01	9031119-01	9031119-01	Shoulder Screw
11	9051519-01	9051519-01	9051519-01	Spacer, Cam Switch
12	9101160-01	9101160-01	9101160-01	Cam Switch
13	3051145-02	3051145-02	3051145-02	Insulator, Switch
14	9031008-44	9031008-44	9031008-44	Pan Head Machine Screw
15	9031120-01	9031120-01	9031120-01	Speed Nut Plate
	2061962-02S	2061962-02S	2061962-02S	Complete Assembly

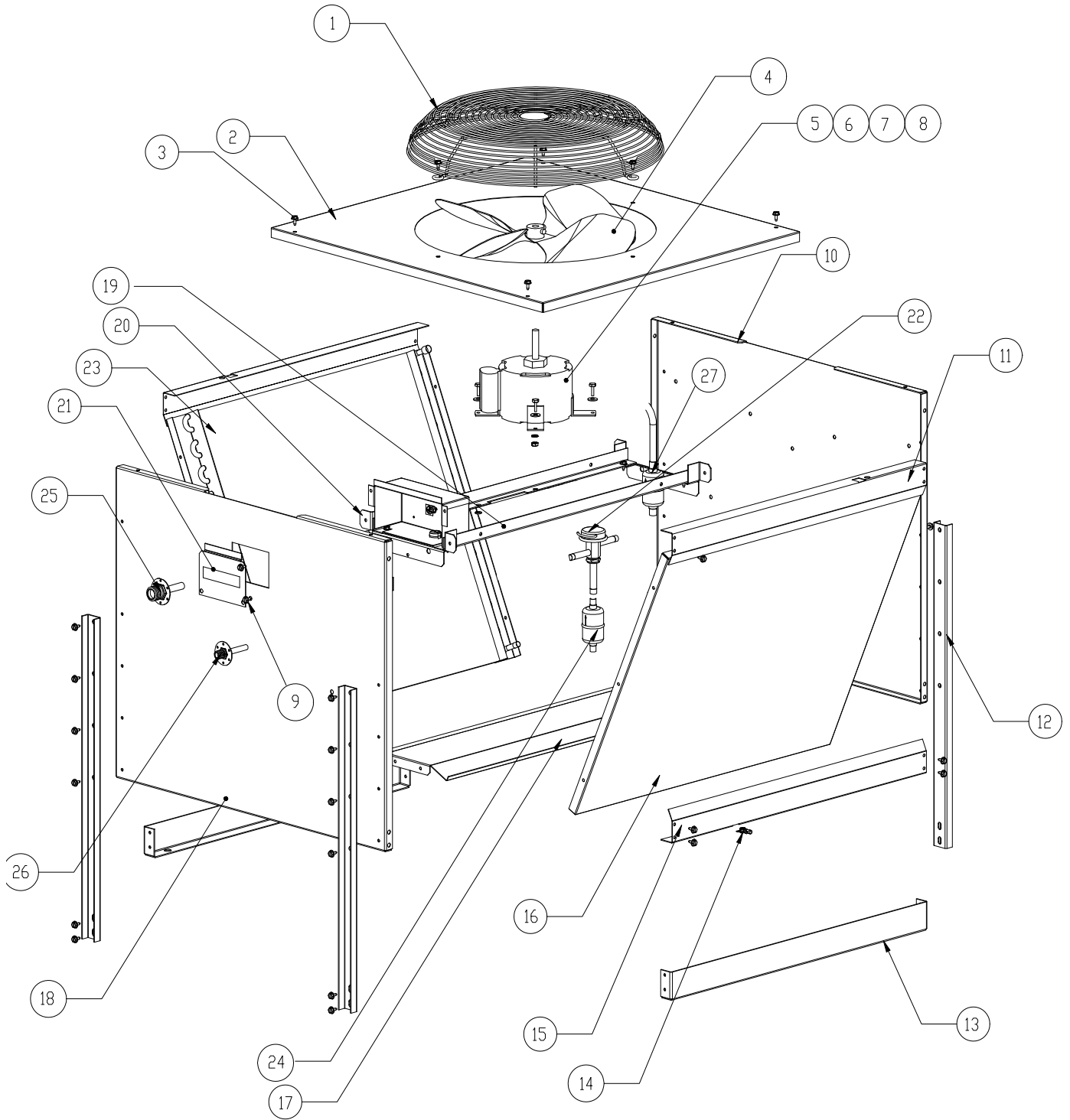

Item No.	Model Number		Description
	VRC1001	VRC1061	
1	9131452-01	9131452-01	Fan Guard
2	3013222-01	3013222-01	Top Panel
3	9031019-04	9031019-04	¼-20 x 1/2 Screw
4	9131451-01	9131451-01	Fan Blade
5	9161117-02	9161117-01	Fan Motor
6	9031001-02	9031001-02	¼-20 x ¾ Cap Screw
7	9031003-01	9031003-01	Flat Washer
8	9031118-02	9031118-02	Flanged Lock Nut ¼-20
9	9031019-04	9031019-04	¼-20 x 1/2 Screw
10	3013224-01	3013224-01	Rear Panel
11	3013226-01	3013226-01	Brace
12	3013227-01	3013227-01	Leg
13	3013228-01	3013228-01	Leg Brace
14	N/A	N/A	T-Nut-Shipping Only
15	3013226-01	3013226-01	Brace
16	3013232-01	3013232-01	Cover Panel
17	3013225-01	3013225-01	Center Panel
18	3013223-01	3013223-01	Front Panel
19	3013234-01	3013234-01	Motor Brace
20	3013233-01	3013233-01	Motor Brace Support
21	3013229-01	3013229-01	Junction Box Cover
22	9151142-02	9151142-02	Head Pressure Control Valve
23	9141130-01	9141130-01	Condenser
24	9151143-01	9151143-01	Filter
25	9091001-12	9091001-12	1/2 Coupling
26	9091001-11	9091001-11	3/8 Coupling
27	9151143-02	9151143-02	Filter

ICE0500R ICE0606R
ICE0605R