

**SERVICE MANUAL**

**G  
E  
E  
S**

**SV 135**

**SV 215**

**SV 315**

**SV 385**

**SV 535**

**R 404 A VERSION**

**Electronic  
modular cubers**

**TABLE OF  
CONTENTS**

Table of contents	2
Specifications	3-12
<b>FOR THE INSTALLER</b>	
Introduction	13
Storage bin	13
Standard legs	13
Important operating requirements	13
Select location	14
Storage bin	14
Ice machine	14
Stacking instructions	14
Final check list	16
<b>FOR THE PLUMBER</b>	
<b>Conform to all applicable codes</b>	
Water inlet	15
Drains	15
<b>For the electrician</b>	
Electrical connections	15
<b>START-UP</b>	
Start-up cycle	15
Freezing cycle	15
Harvest cycle	15
<b>OPERATION</b>	
Refrigeration during freeze	19
Water system	20
Refrigeration system during harvest	21
Water system	21
Control sequence	21
Alarm conditions	22
PC Board set up	23
<b>SERVICE SPECIFICATIONS</b>	
Component	24
Operating characteristics	24
<b>COMPONENT DESCRIPTION</b>	
Component description	25
<b>WIRING DIAGRAM</b>	
SV 135-215-315-385-535 air/water cooled	28
SV 385-535 air/water cooled	29
<b>SERVICE DIAGNOSIS</b>	
Service diagnosis	30
<b>MAINTENANCE &amp; CLEANING INSTRUCTION</b>	
Icemaker	31
Ice storage bin	31
Cabinet exterior	31
Cleaning (Icemaker)	31-32

**SPECIFICATIONS**

**MODULAR CUBER SV 135**



ice making capacity

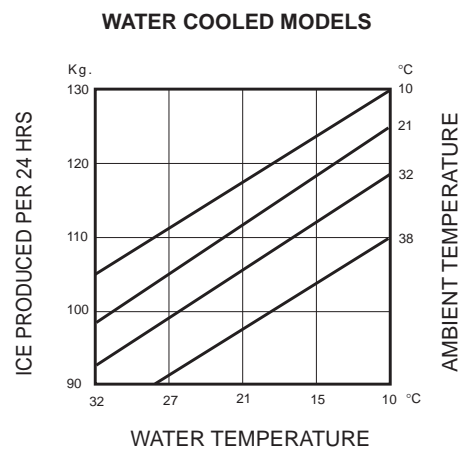
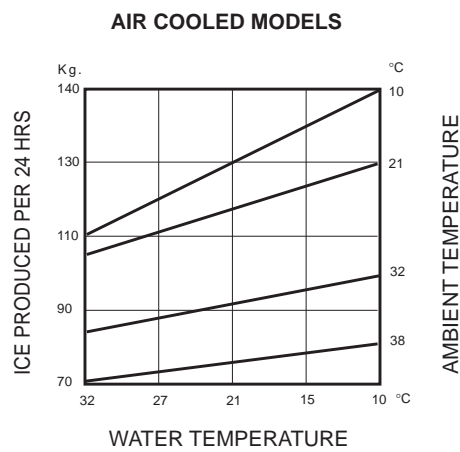

**NOTE.** To keep your Modular cuber performing at its maximum capacity, it is necessary to perform periodic maintenance as outlined on page 31 of this manual.

**SPECIFICATIONS (CONT'D)**

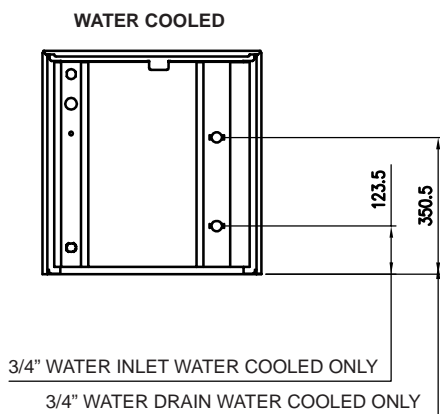
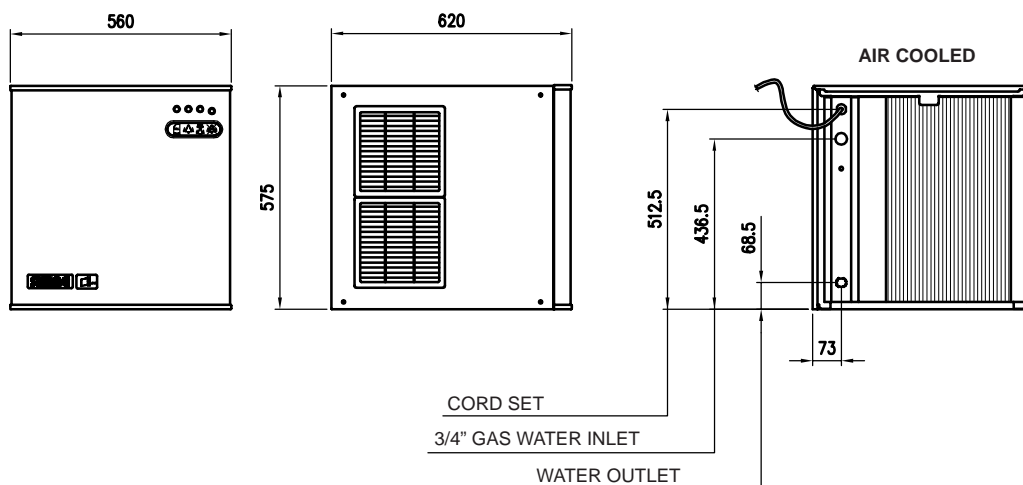

Accessoires  
KSC 300 - Cube stacking kit

Dimensions:  
 HEIGHT 575 mm. (22" 1/2)  
 WIDTH 560 mm. (22")  
 DEPTH 620 mm. (24" 1/2)  
 WEIGHT 55 Kgs.

**SV 135 - MACHINE SPECIFICATIONS**

Model	Cond. unit	Finish	Comp. HP	Water req. lt/24 HR
<b>SV 135 - AS</b> <b>SV 135 - WS</b>	Air Water	Stainless Steel	3/4	300 1500*

Model	Basic electr.	amps	Start amps	watts	Electric power cons. Kwhx24 HR.	N. of wires	Amps Fuse
<b>SV 135 - AS</b> <b>SV 135 - WS</b>	220-240/50/1	3,8 3,3	18	780 650	18.7 15.6	3x1,5 mm <sup>2</sup>	10

Cubes per harvest: 132 Full - 264 Half  
 \* With water at 15°C

# SV 135

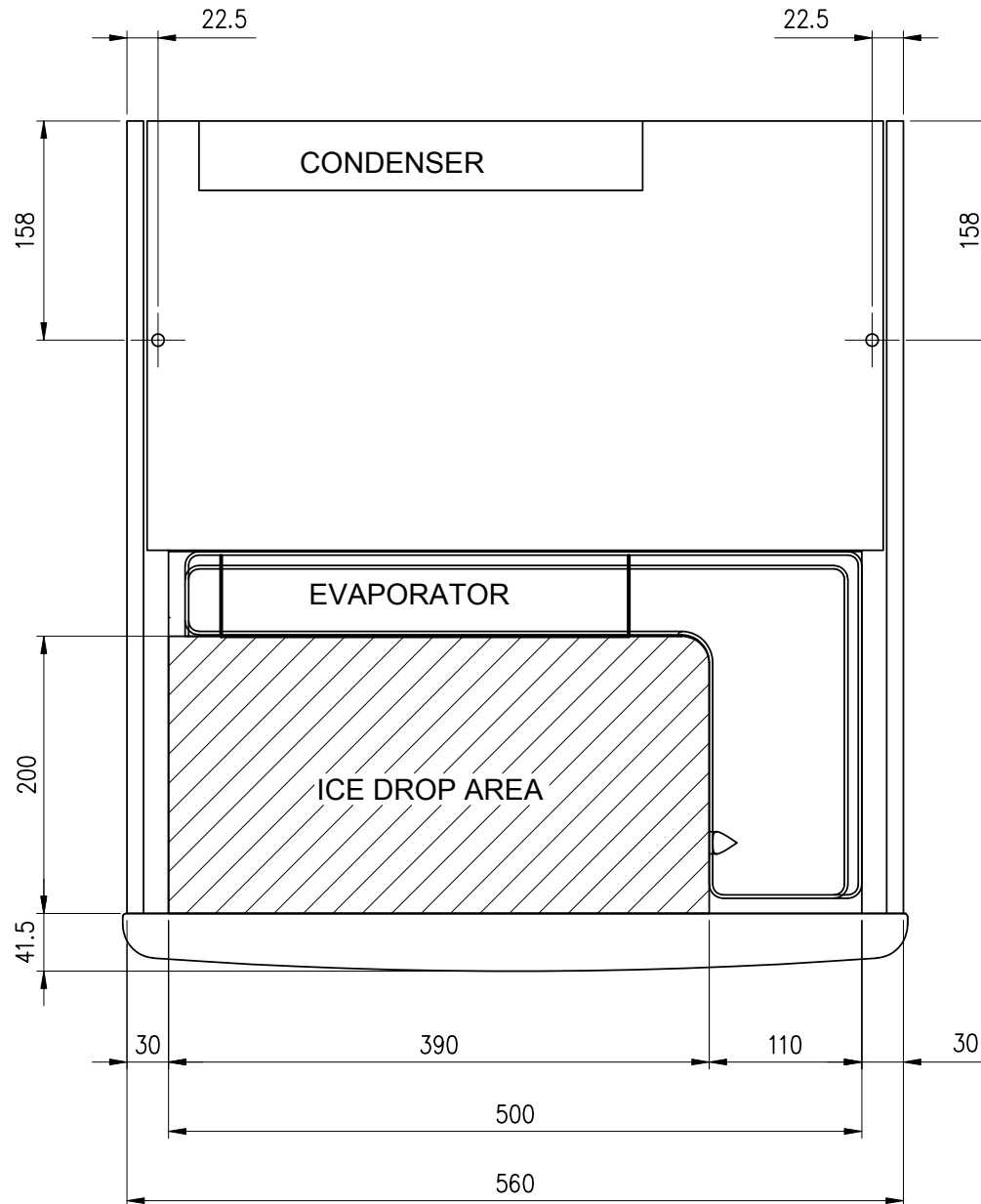

**SPECIFICATIONS**

**MODULAR CUBER SV 215**



ice making capacity

**AIR COOLED MODELS**

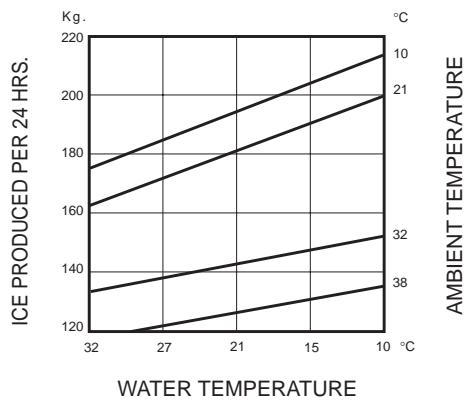

**WATER COOLED MODELS**

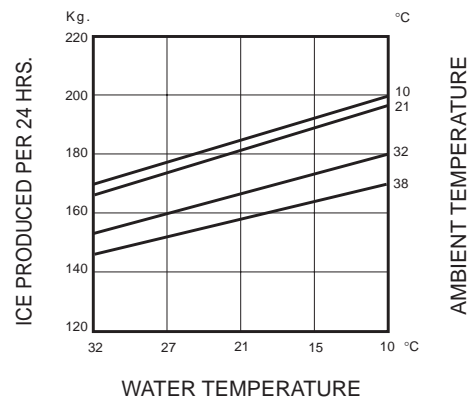

**NOTE.** To keep your Modular cuber performing at its maximum capacity, it is necessary to perform periodic maintenance as outlined on page 31 of this manual.

**SPECIFICATIONS (CONT'D)**

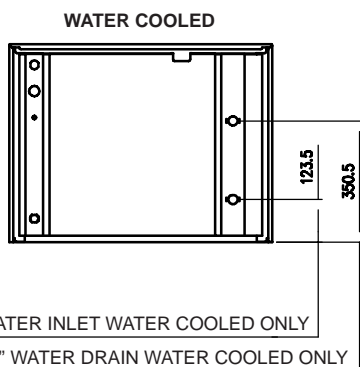
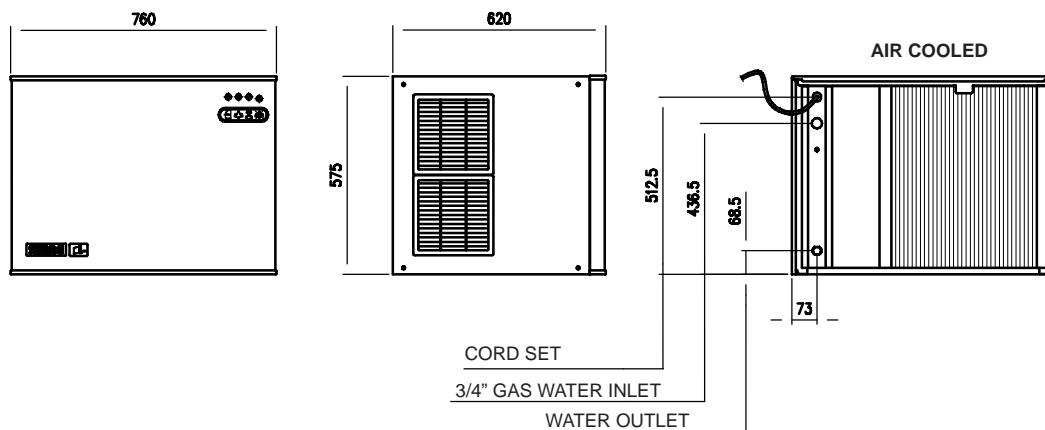

Accessoires  
KSC 450 - Cube stacking kit

Dimensions:  
 HEIGHT 575 mm. (22" 1/2)  
 WIDTH 760 mm. (30")  
 DEPTH 620 mm. (24" 1/2)  
 WEIGHT 77 Kgs.

**SV 215 - MACHINE SPECIFICATIONS**

Model	Cond. unit	Finish	Comp. HP	Water req. lt/24 HR
<b>SV 215 - AS</b>	Air	Stainless Steel	7/8	340
<b>SV 215 - WS</b>	Water			1900*

Model	Basic electr.	amps	Start amps	watts	Electric power cons. Kwhx24 HR.	N. of wires	Amps Fuse
<b>SV 215 - AS</b>	220-240/50/1	6	29	1000	24.0	3x1,5 mm <sup>2</sup>	16
<b>SV 215 - WS</b>		5		900	21.6		

Cubes per harvest: 204 Full - 408 Half  
 \* With water at 15°C

# SV 215



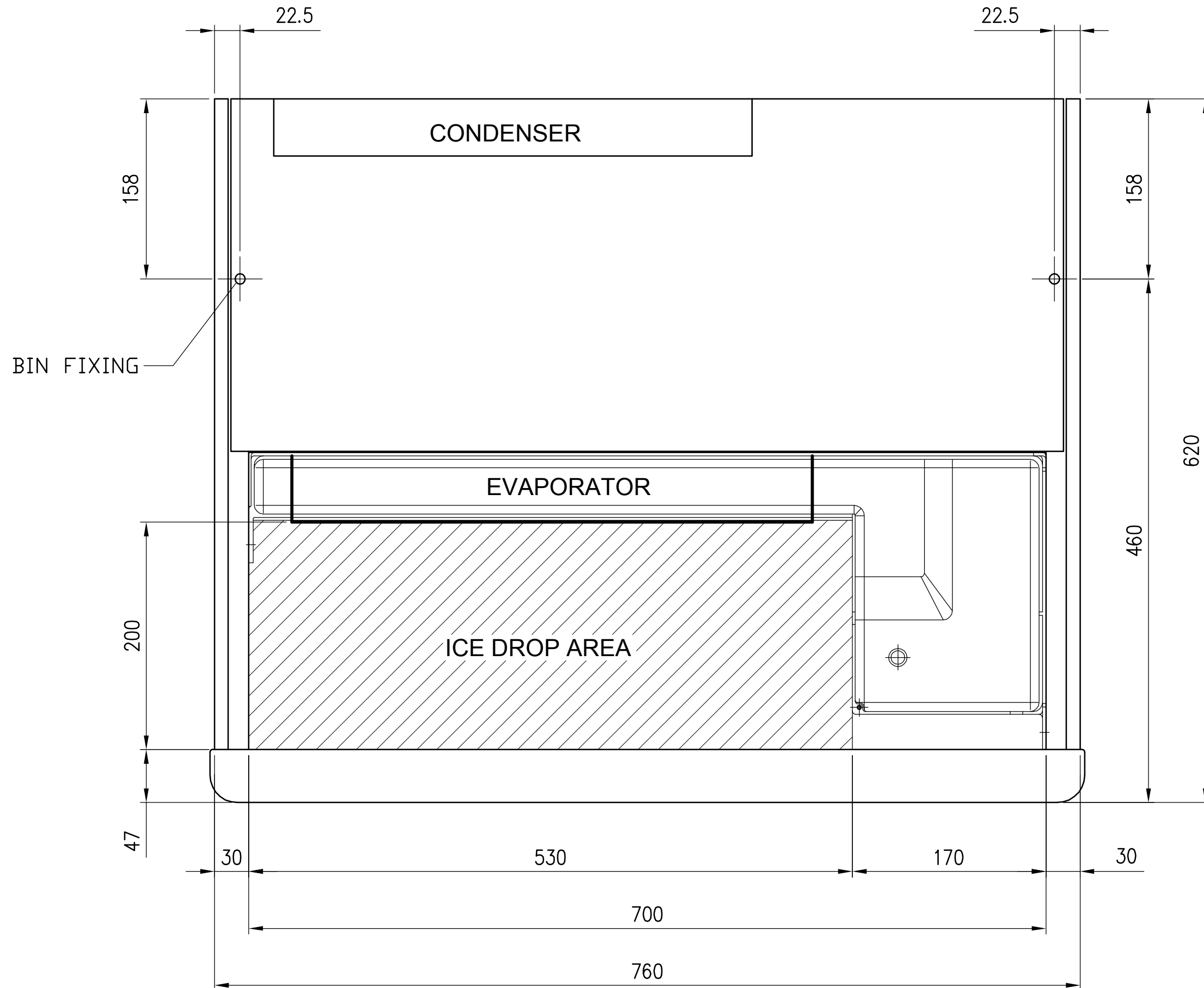

**SPECIFICATIONS**

**MODULAR CUBER SV 315**



**ice making capacity**

**AIR COOLED MODELS**

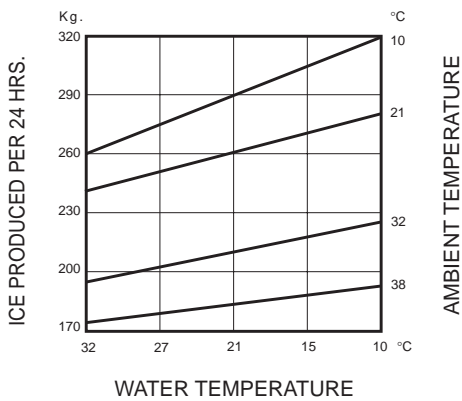

**WATER COOLED MODELS**

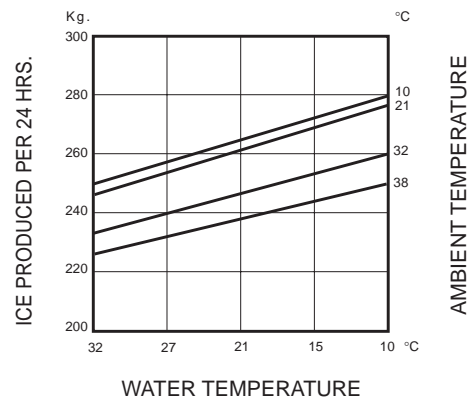

**NOTE.** To keep your Modular cuber performing at its maximum capacity, it is necessary to perform periodic maintenance as outlined on page 31 of this manual.

**SPECIFICATIONS (CONT'D)**

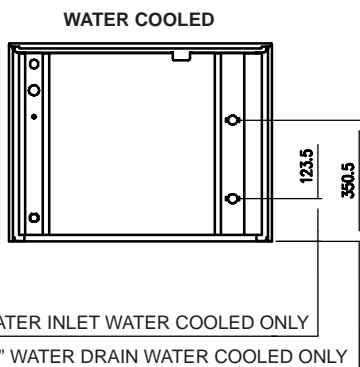
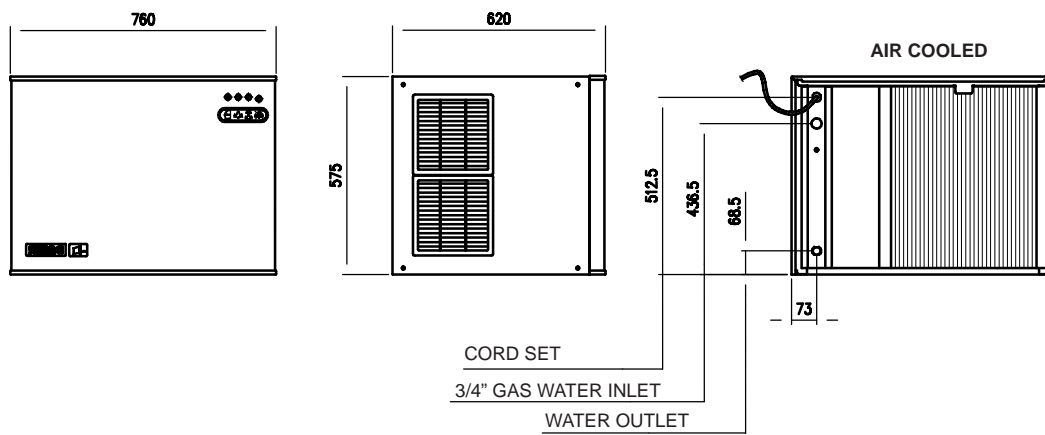

Accessoires  
KSC 450 - Cube stacking kit

Dimensions:  
 HEIGHT 575 mm. (22" 1/2)  
 WIDTH 760 mm. (30")  
 DEPTH 620 mm. (24" 1/2)  
 WEIGHT 77 Kgs.

**SV 315 - MACHINE SPECIFICATIONS**

Model	Cond. unit	Finish	Comp. HP	Water req. lt/24 HR
<b>SV 315 - AS</b> <b>SV 315 - WS</b>	Air Water	Stainless Steel	1 1/2	470 2750*

Model	Basic electr.	amps	Start amps	watts	Electric power cons. Kwhx24 HR.	N. of wires	Amps Fuse
<b>SV 315 - AS</b> <b>SV 315 - WS</b>	220-240/50/1	10 7.5	31	1600 1300	38.4 31.2	3x1,5 mm <sup>2</sup>	16

Cubes per harvest: 204 Full - 408 Half  
 \* With water at 15°C

# SV 315

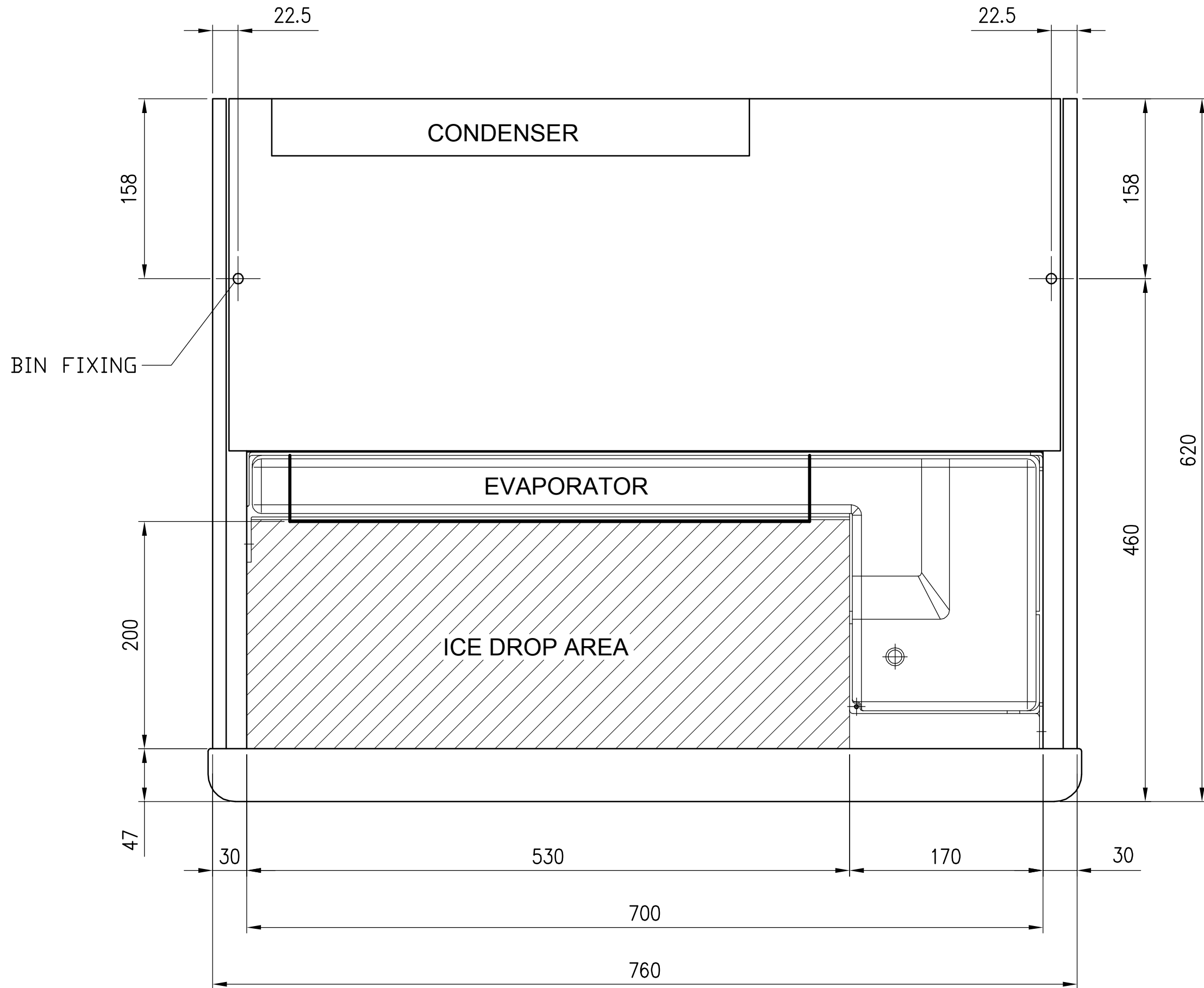

**SPECIFICATIONS**

**MODULAR CUBER SV 385**



ice making capacity

**AIR COOLED MODELS**

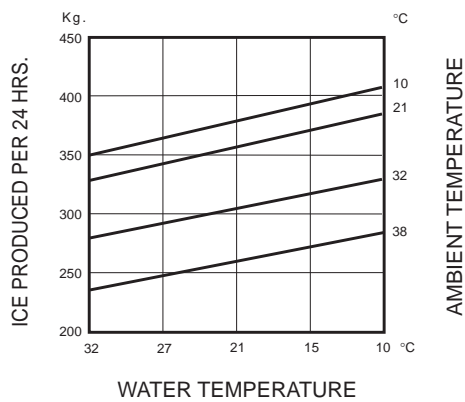

**WATER COOLED MODELS**

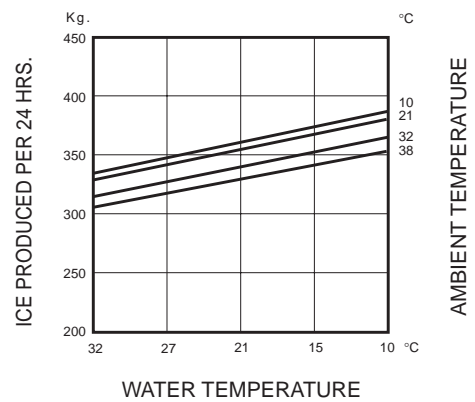

**NOTE.** To keep your Modular cuber performing at its maximum capacity, it is necessary to perform periodic maintenance as outlined on page 31 of this manual.

**SPECIFICATIONS (CONT'D)**

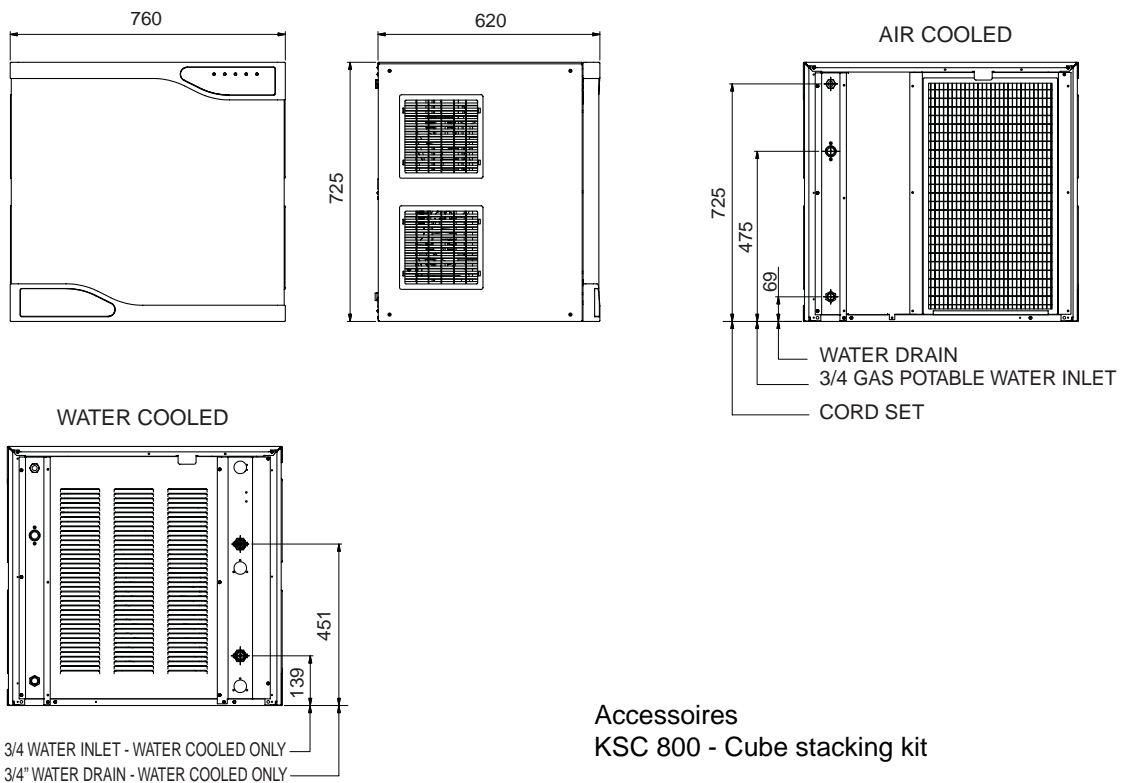

Accessoires  
KSC 800 - Cube stacking kit

Dimensions:  
 HEIGHT 725 mm. (28" 1/2)  
 WIDTH 760 mm. (30")  
 DEPTH 620 mm. (24" 1/2)  
 WEIGHT 97 Kgs.

**SV 385 - MACHINE SPECIFICATIONS**

Model	Cond. unit		Finish		Comp. HP	Water req. lt/24 HR	
<b>SV 385 - AS</b>	Air		Stainless Steel		2.5	650	
<b>SV 385 - WS</b>	Water					3300*	
Model	Basic electr.	amps	Start amps	watts	Electric power cons. Kwhx24 HR.	N. of wires	Amps Fuse
<b>SV 385 - AS</b>	380-400/50/3	5.5	26.5	2300	55.2	5x1,5 mm <sup>2</sup>	10
<b>SV 385 - WS</b>				1900	45.6		
Cubes per harvest: 289 Full - 578 Half							
* With water at 15°C							

# SV 385

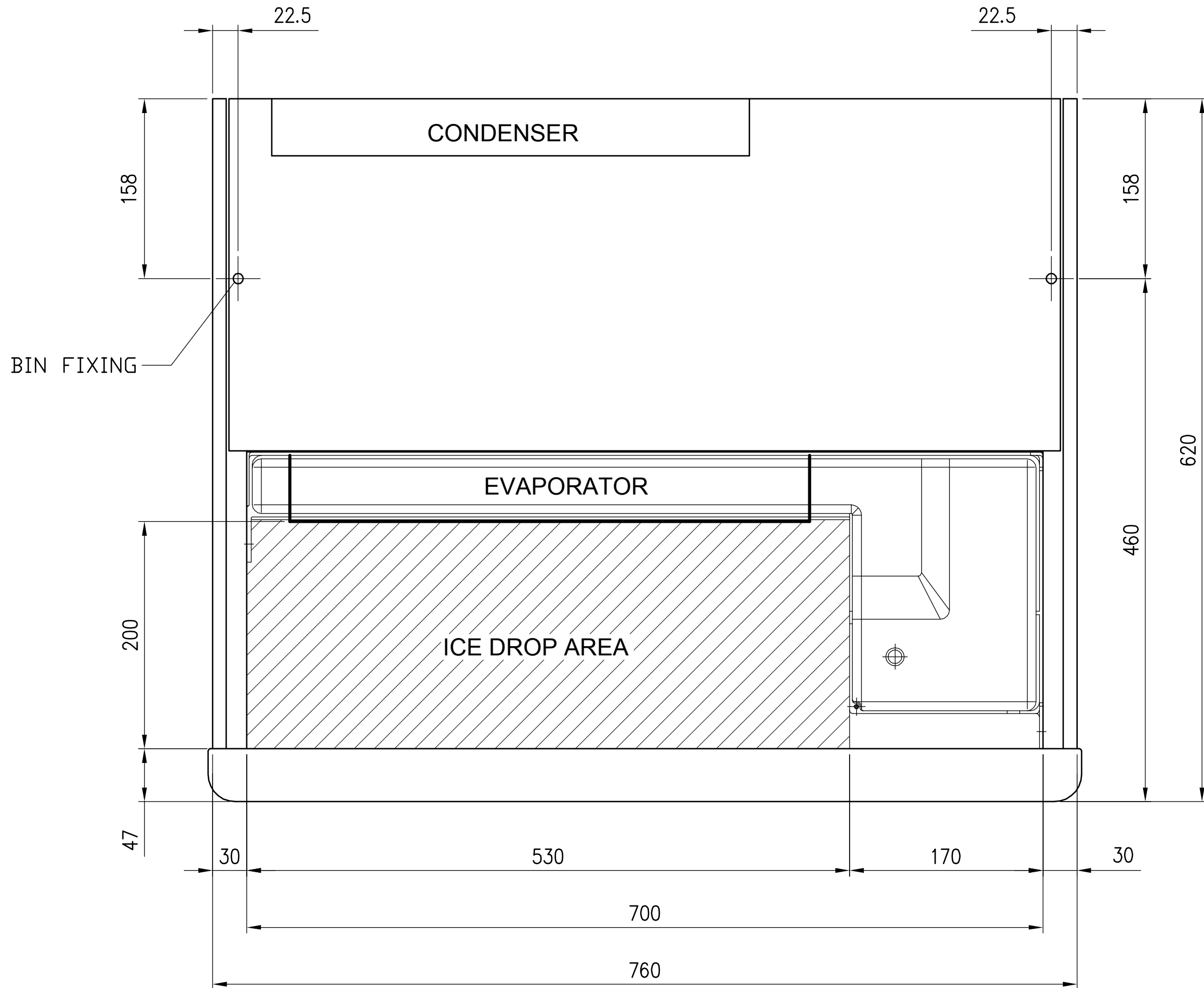

**SPECIFICATIONS**

**MODULAR CUBER SV 535**



ice making capacity

**AIR COOLED MODELS**

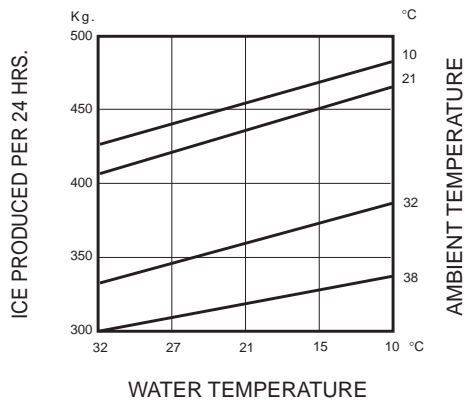

**WATER COOLED MODELS**

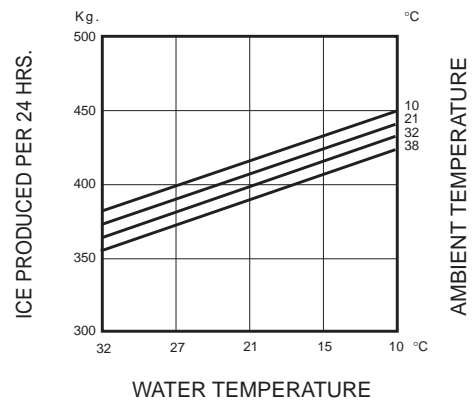

**NOTE.** To keep your Modular cuber performing at its maximum capacity, it is necessary to perform periodic maintenance as outlined on page 31 of this manual.

**SPECIFICATIONS (CONT'D)**

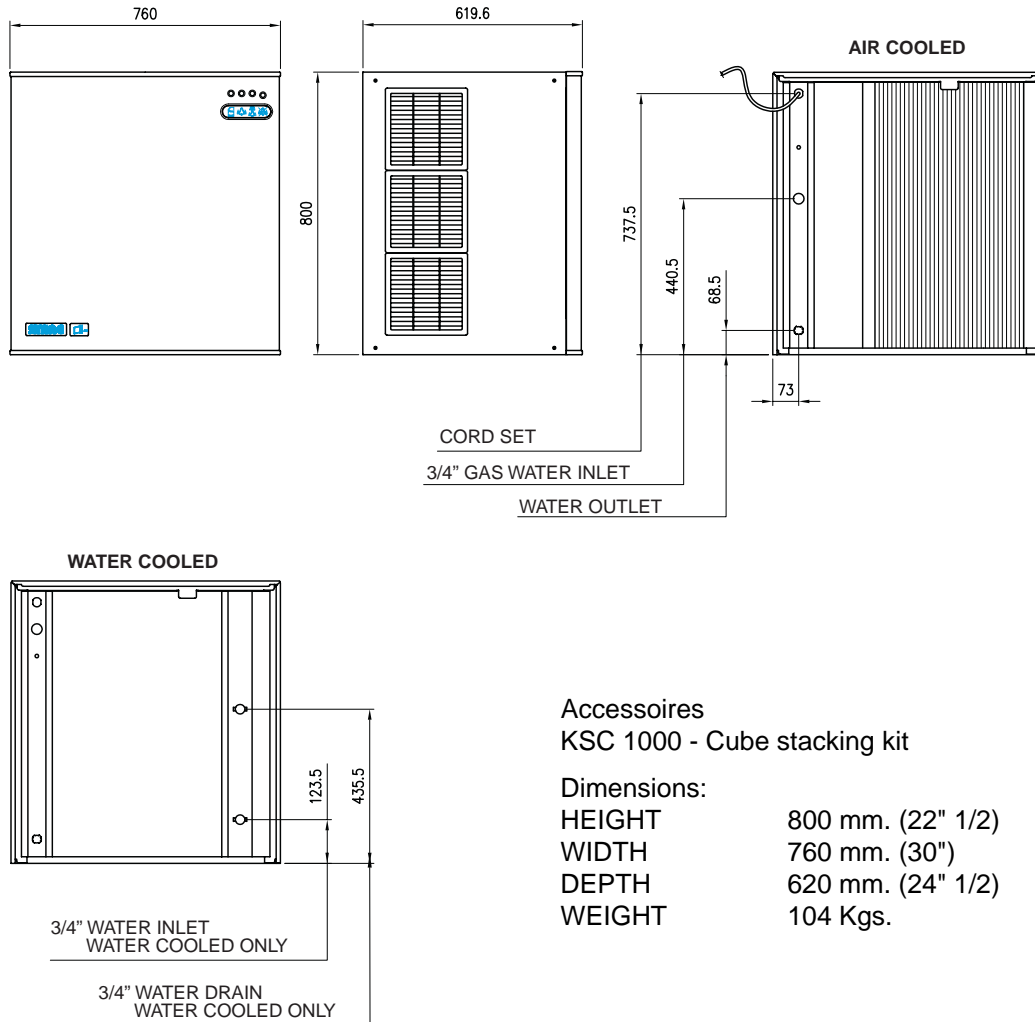

Accessoires  
KSC 1000 - Cube stacking kit

Dimensions:  
 HEIGHT 800 mm. (22" 1/2)  
 WIDTH 760 mm. (30")  
 DEPTH 620 mm. (24" 1/2)  
 WEIGHT 104 Kgs.

**SV 535 - MACHINE SPECIFICATIONS**

Model	Cond. unit	Finish	Comp. HP	Water req. lt/24 HR
<b>SV 535 - AS</b>	Air	Stainless Steel	2.5	700
<b>SV 535 - WS</b>	Water			3500*

  

Model	Basic electr.	amps	Start amps	watts	Electric power cons. Kwhx24 HR.	N. of wires	Amps Fuse
<b>SV 535 - AS</b>	380-400/50/3	5.5	26.5	2500	60.0	5x1,5 mm <sup>2</sup>	10
<b>SV 535 - WS</b>				2100	50.4		

Cubes per harvest: 340 Full - 680 Half  
 \* With water at 15°C



# SV 535

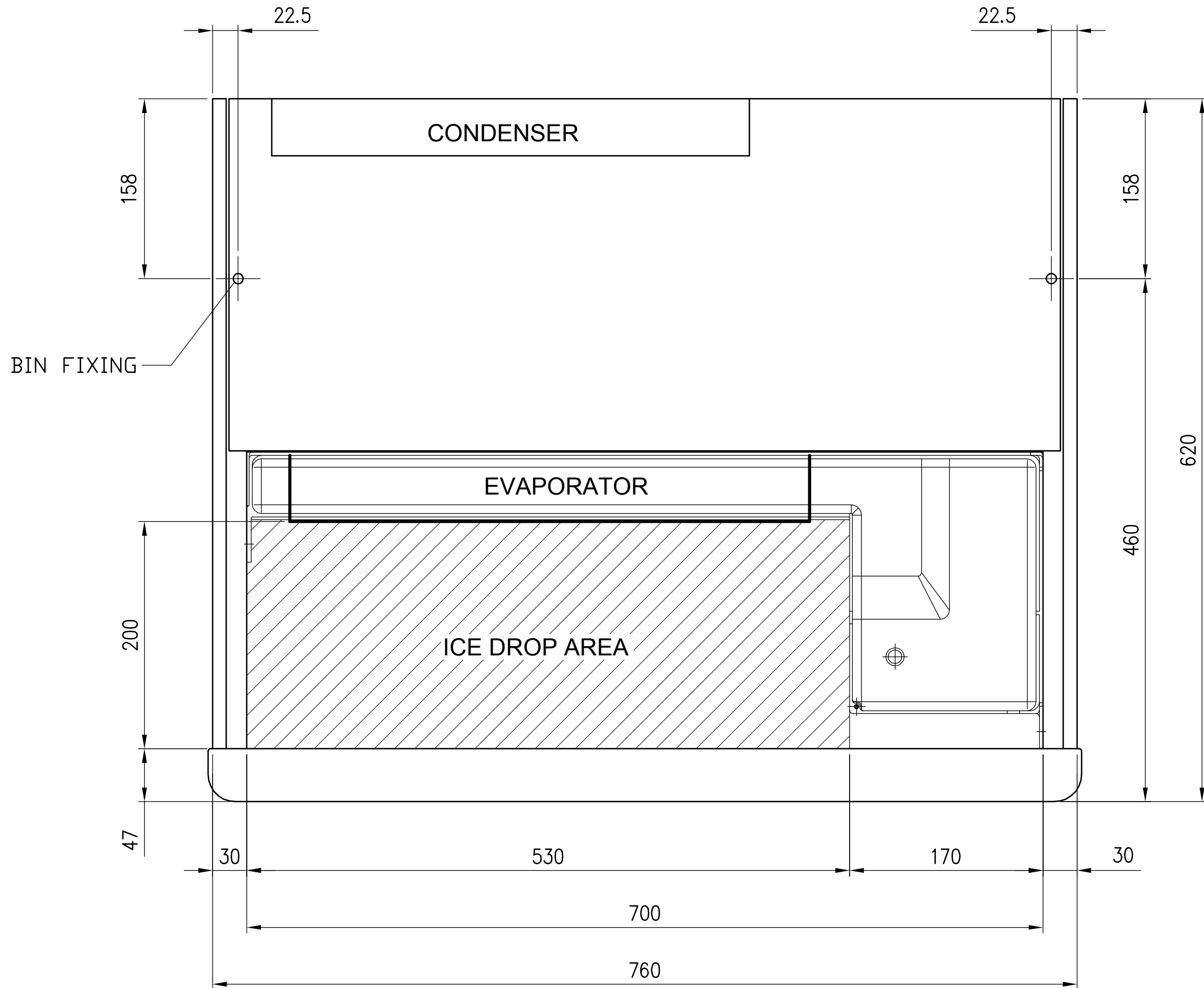

## FOR THE INSTALLER

### INTRODUCTION

These instructions provide the specifications and the step-by-step procedures for the installation, start up and operation for the SIMAG Model SV 135-215-315-385-535 Modular Cubers. The Models SV 135-215-315-385-535 Modular Cubers are quality designed, engineering and constructed, and are thoroughly tested icemaking systems, providing the utmost in flexibility to fit the needs of a particular user.



**INSTALLATION NOTE:** Allow 15 cm. minimum space at sides and back for ventilation and utility connections.

### STORAGE BIN

The SV 135 stack on top of Simag bin model R 85; the SV 125-315-385-535 stack onto SIMAG bin model R 155.

### Refrigerant R 404 A

Charge per nameplate rating.

**STANDARD LEGS:** Furnished with storage bin. Four legs screw into mounting sockets on cabinet base. Provide 18.5 cm. (7") minimum height including adjustable leveling foot. Optional Kit Casters for R 155 (KRB 550) are available on request.

### IMPORTANT OPERATING REQUIREMENTS

	MINIMUM	MAXIMUM
Air Temperature	10°C (50°F)	40°C (100°F)
Water Temperature	5°C (40°F)	35°C (90°F)
Water Pressures	1 bar gauge	5 bar gauge
Electrical Voltage Variations Voltage rating specified on nameplate	-10%	+10%

Extended periods of operation exceeding these limitations constitutes misuse under the terms of Manufacturer's Limited Warranty, resulting in a loss of warranty coverage.

**SELECT LOCATION**

The first step in installing the equipment is to select the location. The purchaser of the unit will have a desired spot in mind, check out that spot to insure that it is:

- indoors, in an environment that does not exceed the air and water temperature limitations for the equipment.
- that the necessary utilities are available including the correct voltage electrical power.
- that there be space around the installed machine for service, 15 cm. minimum left, right, and rear for air-cooled models.

**STORAGE BIN**

The SIMAG bins for these units are the R 85, R 155 and R 255.

Other bins may be available with bin tops to vary the storage capacity. Lay the bin on its back, using cardboard from the carton to support it, screw in the legs.

Stand the bin upright, and correct any possible small tears in the machine mounting gasket with food grade silicone sealant.

**ICE MACHINE**

The use of a mechanical lift is recommended for lifting the uncrated icemaker onto the bin.

Remove front, top and sides panels.

Place the unit directly onto the bin, align it with the back of the bin. Locate the hardware package, take out two mounting screws, and use them to secure the icemaker to the two sides of the bin. See illustration below.

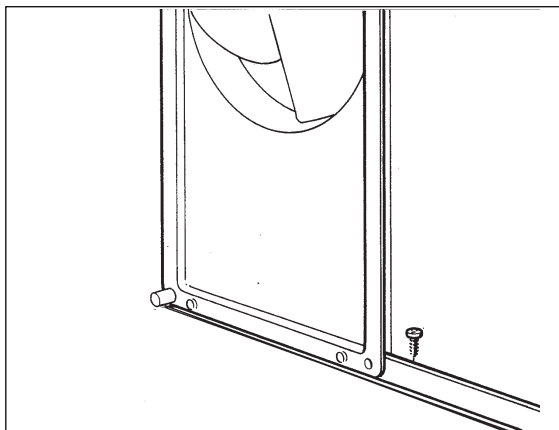

Remove all shipping material as well as the masking tapes from the ice deflector/evaporator cover.



Remove first the ice deflector/evaporator cover then the masking tape from the ice thickness sensor.



**SV 135 - AIR SEPARATOR**

Install on the back side of the machine the air baffle as per instruction provided with it.



**STACKING INSTALLATION**

To stack a second SV onto the present one, first remove the top panel from the lower machine. Add a bead of food grade silicone sealant to the top edges of the lower units freezing compartment. Lift the top machine onto the bottom

machine, (the use of a mechanical lift is recommended for this step). Align the two machines cabinets, and using the 2 screw from the top units, hardware package, fasten the two units together at the side cabinets.

Then make use of the Stacking Kit KSC 300, KSC 450, KSC 800 and KSC 1000, to be mounted as per fitting instructions included in their package, respectively on SV 135, SV 215-315-385 and SV 535 located in the bottom for proper conveying, of the ice cubes made by the top unit, into the storage bin.

With food grade silicone perfectly seal the edge between the freezing compartment of the upper machine and of the bottom machine so to avoid any possible leak of water through the clearance in between.

## FOR THE PLUMBER

### CONFORM TO ALL APPLICABLE CODES

#### WATER INLET

**AIR-COOLED MODELS:** The recommended water supply is **cold** water connected to the - 3/4" gas - male fitting at the back of the cabinet. Install a hand valve near the machine to control the water supply.

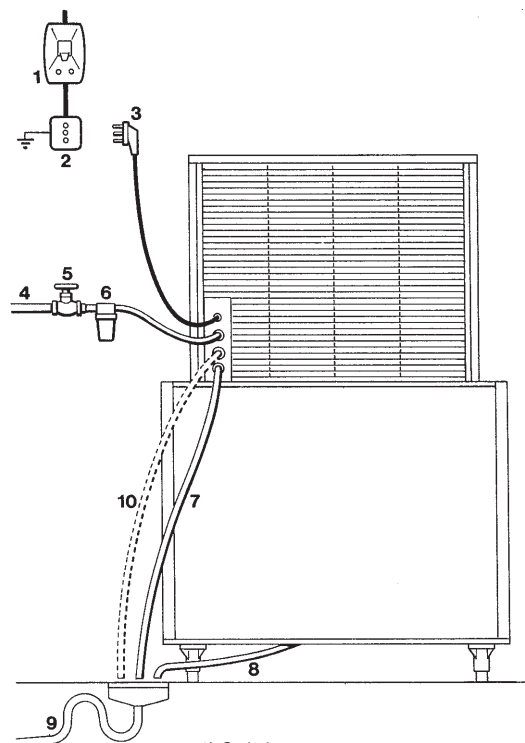

- 1) Switch
- 2) Plug receptacle
- 3) Electrical plug
- 4) Water inlet
- 5) Shut-off valve
- 6) Water filter
- 7) Water outlet line
- 8) Bin water outlet line
- 9) Open vented water drain
- 10) Water outlet from the condenser:  
water cooled version only.

When choosing the water supply for the SV Cuber, consideration should be given to:

- A. Length of run.
- B. Water clarity and purity.
- C. Adequate water supply pressures.

Since water is the most important single ingredient in producing ice you cannot over emphasize the three items listed above. Low water pressure, below 1 bar may cause malfunction, of the icemaker unit. Water containing excessive minerals will tend to produce cloudy colored ice cubes, plus scale build-up on parts in the water system.

Heavily chlorinated water can be controlled using charcoal or carbon filters.

## DRAINS

**AIR-COOLED MODELS:** There is one 20 mm. dia sump drain fitting at the back of the cabinet. Insulations in high humidity areas is recommended. The ideal drain receptacle would be a trapped and vented floor drain.

**WATER-COOLED MODELS:** Besides the above drain, **a separate** condenser drain must be run. Connect it to the - 3/4" gas - condenser drain connection at the back of the cabinet.

**STORAGE BIN:** **A separate** gravity type drain needs to be run, similar to the air-cooled sump drain. **Insulation of this drain line is recommended.**

## FOR THE ELECTRICIAN

### ELECTRICAL CONNECTIONS

The unit come equipped with an electrical cord for power supply. The lead wires must be connected to an electrical plug that corresponds to the local electrical codes and requirements or to a separate two poles disconnect box with opening to the contacts of about 3 millimeters.

The disconnect box should be placed close to the selected ice maker location to be easily and prompt reached.

Undersized wiring or improperly installed electrical circuit will result in major problems and malfunctions.

Voltage variations should not exceed ten percent.

**IMPORTANT - All plumbing and electrical connections must be made by licensed plumbers and electricians, this one must follow the electrical specifications printed on the ice maker nameplate.**

**NOTE: All SIMAG Cubers require a neutral wire and a solid earth ground wire to prevent possible severe Electrical Shock Injury to individuals or extensive damage to equipments.**

**FINAL CHECK LIST**

1. Is the cabinet/bin level?
2. Is the cuber in a location where ambient temperatures are a minimum of 10°C (50-degrees F.) all year around and to not exceed a maximum of 40°C. (100°F.).
3. Is there at least a 15 cm. clearance behind and around the cabinet for all connections and for proper air circulation?
4. Have all electrical and piping connections been made?
5. Has the electrical power supply wiring been properly connected and the voltage tested and checked against the nameplate rating? Has the unit properly grounded.
6. Is the water supply line shutoff valve installed and opened and has the inlet water supply pressure been checked to insure a minimum of 1 bar without exceeding a maximum of 5 bar.
7. Have the compressor holddown bolts been checked to be sure the compressor is snug on the mounting pads.
8. Check all refrigerant lines and conduit lines to gard against vibration and possible failure.
9. Has the cuber and the bin been wiped clean with clean damp cloths?
10. Has the owner/user been given the User Manual and instructed on how to operate the icemaker and the importance of periodic maintenance?
11. Has the owner/user been given the name and telephone number of the Authorized SIMAG Distributor or Service Agency serving him?
12. Has the Manufacturer's Registration Card been properly filled out? Check for correct Model and Serial Numbers from nameplate, then mail the completed card to the Manufactured.

**TYPICAL STACKING INSTALLATION**

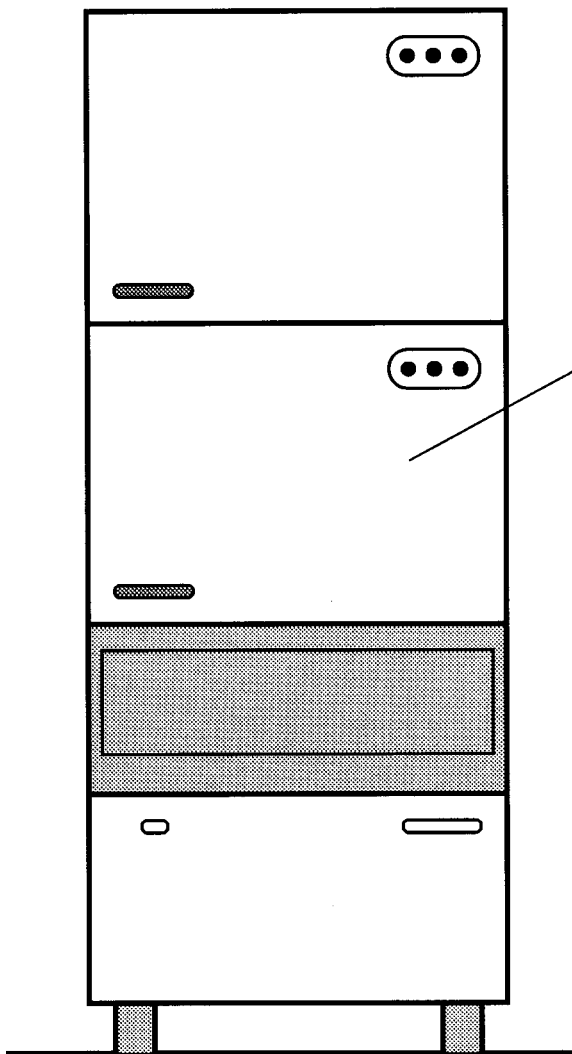

KIT STACKING KSC 300: TO STACK 2 SV 135's  
 KIT STACKING KSC 450: TO STACK 2 SV 215-315's  
 KIT STACKING KSC 800: TO STACK 2 SV 385's  
 KIT STACKING KSC 1000: TO STACK 2 SV 535's

## START-UP

### START-UP CYCLE

1. Open the water tap/valve and switch ON the power on the electrical supply line.
2. The models SV 135-215-315 enter in the Start Up mode with the PC Board energized as well as the **Green LED** of the machine under power while the models SV 385-535 enter in 90 minutes delay time controlled by a special Start Up delay PC Board.

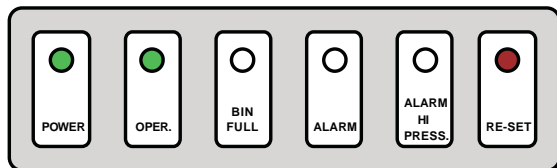

The **Green LED** of machine in operation is energized too, **blinking fast for 40 seconds**.

**NOTE:** The models SV 385-535 are equipped with a compressor crankcase heater and a Start up Delay PC Board set up at 90 minutes. During the first 90 minutes only the compressor crankcase heater is energized warning up the compressor.

3. During the Start Up cycle the components in operation are:
  - Hot gas valve
  - Water Drain Valve
  - Water Pump

### FREEZING CYCLE

1. After the Start Up cycle the machine enters directly into the Freezing cycle with the following components energized:
  - Water Inlet valve
  - Compressor
  - Fan motor (in continuous operation for the first 3 minutes).
2. The LED energized are:
  - Machine under power
  - Machine in operation (steady)



3. Water is coming into the water through the Water Inlet Solenoid Valve till the water reservoir is filled up to the maximum level controlled by a Water Level Sensor.
4. 30 seconds later, the Water Pump starts up.
5. After 3 minutes from the start up of the freezing cycle, the Water Inlet Solenoid Valve is activated again for few seconds till the water reaches the maximum level so to reduce any possibility of slush ice formation.
6. In the meantime the condenser sensor starts to transmit the current to the PC Board keeping in operation the Fan Motor in ON-OFF mode or continuously according to the condenser temperature.

**NOTE:** Do not remove the evaporator deflector cover as it will cause the switching off of the machine at "STORAGE BIN FULL".

7. The machine remains in the freezing cycle with the ice that become thicker till the two metal plates of the Ice Thickness Sensor are covered by the water cascading through the front surface of the ice plate.
8. When the Power is transmitted back to the PC Board continuously through the metal plates of the Ice Thickness Sensor for more then 6", the machine enters in the Pre-Harvest or directly into the Harvest Cycle mode according to:

• **FAN MOTOR IN ON-OFF MODE DURING THE PREVIOUS FREEZING CYCLE**

RISE UP THE CUT IN TEMPERATURE OF THE CONDENSER SENSOR TO 38°C (FAN MOTOR OFF) AND EXTEND THE LENGTH OF FREEZING CYCLE BY 30" MORE THEN GO INTO HARVEST CYCLE

• **FAN MOTOR ALWAYS IN OPERATION DURING THE PREVIOUS FREEZING CYCLE**  
GO STRAIGHT TO THE HARVEST CYCLE

9. First freezing time will range between 15 and 20 minutes. Longer time for temperature above 25°C and shorter time required when temperature are below 25°C. Average complete cycle time is about 22 min.

### HARVEST CYCLE

1. During the harvest cycle the components in operation are:
  - Hot Gas valve
  - Water Drain/Purge Valve
  - Water Pump for the first 40"
  - Compressor

and both

- Machine Under Power
- Machine in Operation

2. 30 seconds after the beginning of the Harvest Cycle, the Water Inlet Solenoid Valve is energized for 10 seconds only in order to have a short flush of fresh water into the sump while the Water Pump is still in operation.

3. The Fan Motor remains in OFF mode unless the Condenser Sensor probe rise up to more than 38°C (same set up as per end of freezing cycle).

4. When the ice plate is falling down from the evaporator, the magnetic switch is activated for a while providing the signal to the PC Board to restart a new freezing cycle.

5. Observe first ice cube harvest and check size of ice cubes; if an adjustment is required thread down or out screw N. 1 as shown on below illustration.

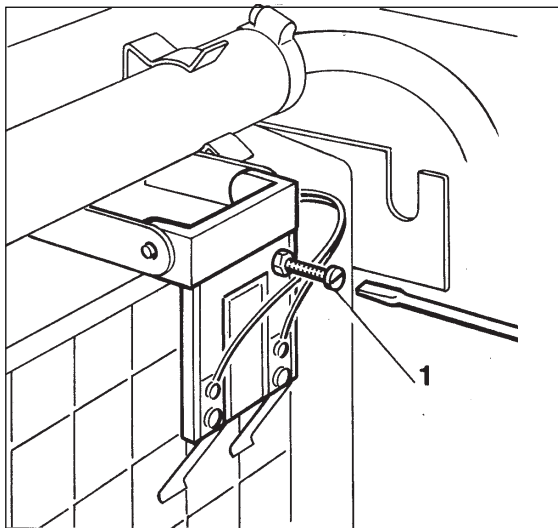

This screw position determines the distance between the sensor reeds and the egg-crate evaporator thus keeping the ice cube at a proper thickness.

**NOTE:** This type of machine produce an "ICE PLATE" that breaks when falls down into the storage bin. Setting the ice thickness sensor in order to have single ice cubes may cause malfunction of the machine.

6. Observe second and third cube harvest. Check if size and shape combination is correct. In areas where extreme problem water conditions exist, filtering or purifying equipment is recommended.

**NOTE:** If water used is too soft, "demineralized" the ice thickness sensor might not be able to sense the water on its reeds, there by it will not switch the unit on harvest cycle. A safety system built in the P.C. Board switches the unit on harvest cycle whenever the freezing period gets longer then 30' or 40'.

**NOTE:** To assure a correct operation of the machine the water must have a **minimum electrical conductivity of 20 us.**

7. Check operation of magnetic switch controlling it by keeping open the bottom end of plastic deflector for more than 30 seconds. The machine must switch off at storage bin full. Release the plastic deflector. The machine should restart in the freezing cycle mode within few seconds going through a 3' delay time.

8. Place again all cabinet panels and screws previously removed.

9. Thoroughly explain to owner/user the significant specifications of the ice maker start-up, reset and operation, going through the procedures in the operating instructions.

Answer all questions about the ice maker by the owner and inform the owner himself of the name and telephone number of the authorized service agency serving him.

## OPERATION

### FREEZE CYCLE

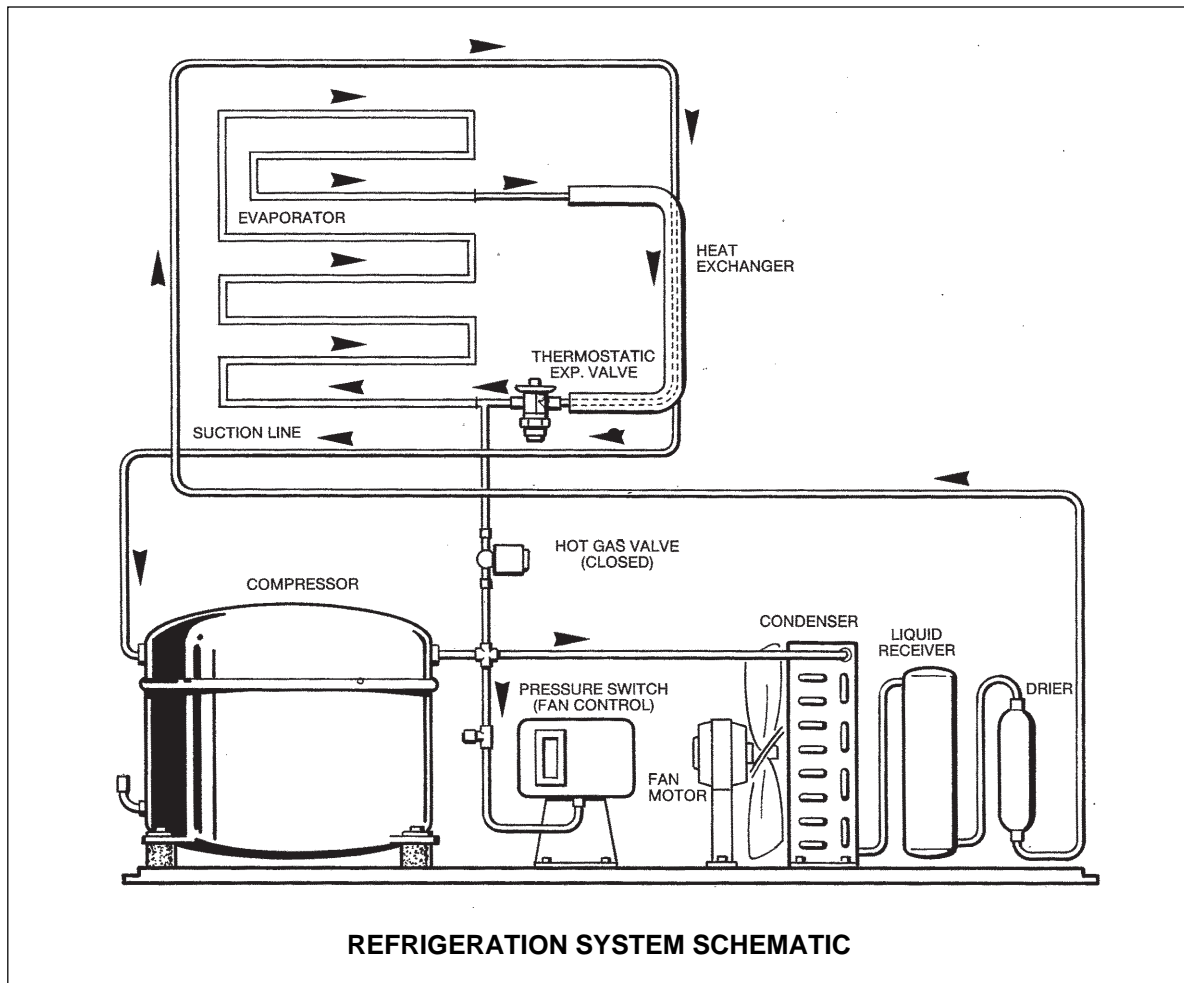

#### REFRIGERATION DURING FREEZE:

This ice machine employs either air or water as a condensing media, the refrigeration system for either one is as follows:

At the hermetic compressor, Refrigerant is compressed into a high temperature, high pressure gas.

The gas moves through the **discharge** line into the **condenser**, air or water-cooled. If air-cooled, the discharge pressure will change with the heat load and the ambient air temperature.

If water-cooled, the discharge pressure is controlled by the amount of water flowing through the **condenser** - which is determined by the water regulating valve.

After the gas is cooled in the condenser, giving up much of its heat, the gas condenses into a high pressure liquid. This liquid travels through the **liquid line** to the metering device, a **thermostatic expansion valve**.

The thermostatic expansion valve meters how much liquid refrigerant is to be allowed into the evaporator section of the refrigeration system.

This is determined by the temperature of the TXV sensing bulb, located on the **suction line** manifold, at the outlet of the **evaporator**.

If the bulb senses a warm suction line, more refrigerant is allowed into the evaporator, (common at the beginning of the freeze cycle) and when the temperature begins to fall, less refrigerant is allowed through.

This is why the suction side gauge pressure will decline throughout the freeze cycle. At the evaporator, the liquid refrigerant released from high pressure, boils off in the low pressure environment and absorbs heat, thus cooling the evaporator surface and anything near it, such as water.

The low pressure refrigerant vapor then is forced through the heat exchanger where any excess liquid refrigerant boils-off, allowing only refrigerant vapor to enter the compressor suction tube, where it is recompressed into high pressure, high temperature gas again and the cycle repeats.



## FREEZE CYCLE

### **WATER SYSTEM**

A combination of a solenoid water inlet valve with a water level sensor is used to control the level of the water into the reservoir/sump.

A pump, running continuously, after the first 30" of freezing cycle, forces the water to the top of the evaporator, where it is distributed through a

water tube and then cascades down the evaporator surface by gravity. As it flows across the refrigerated evaporator, some of the water will be chilled enough to change form, turn to ice, and stay frozen onto the evaporator cells. Most of the water returns to the reservoir, to be sucked back into the pump, and repumped over the evaporator.

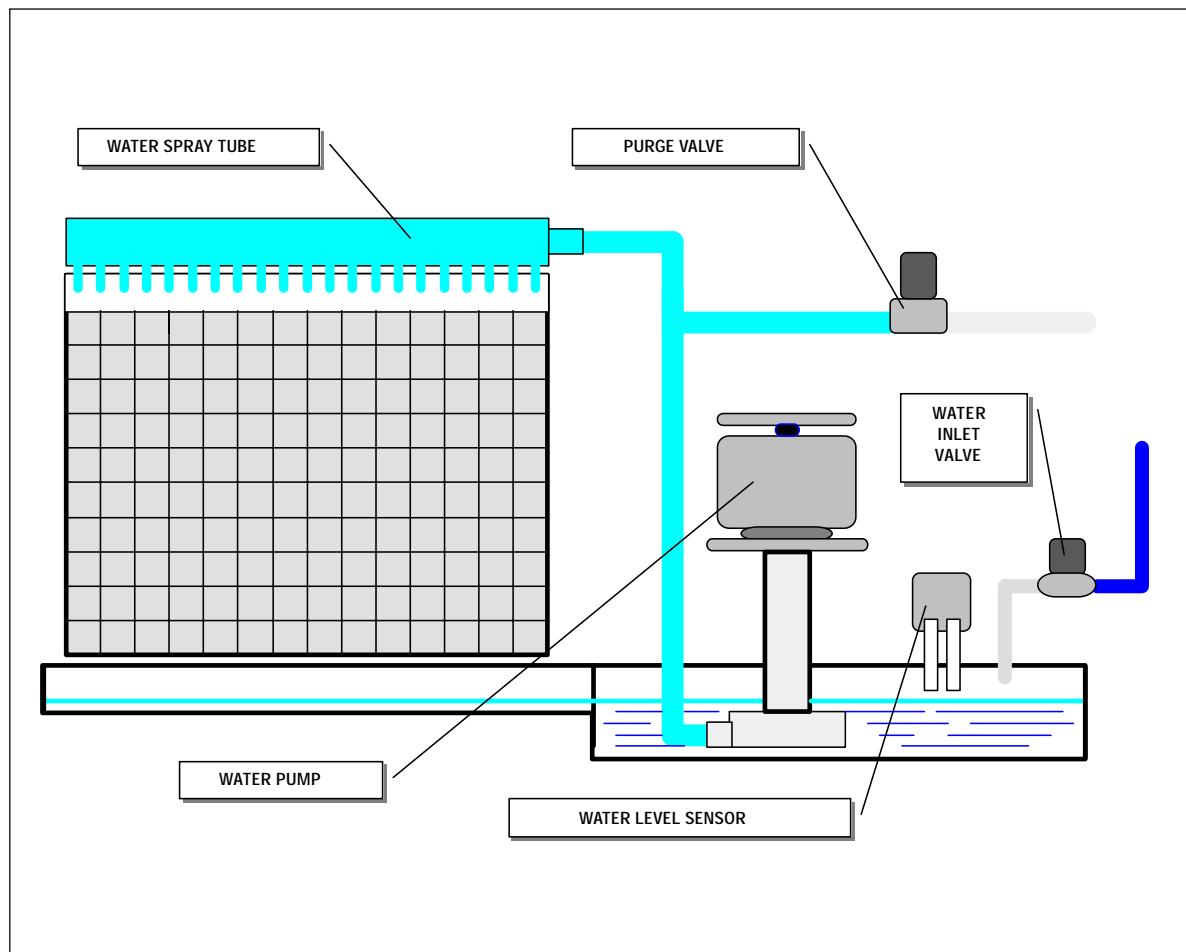

## HARVEST (DEFROST) CYCLE

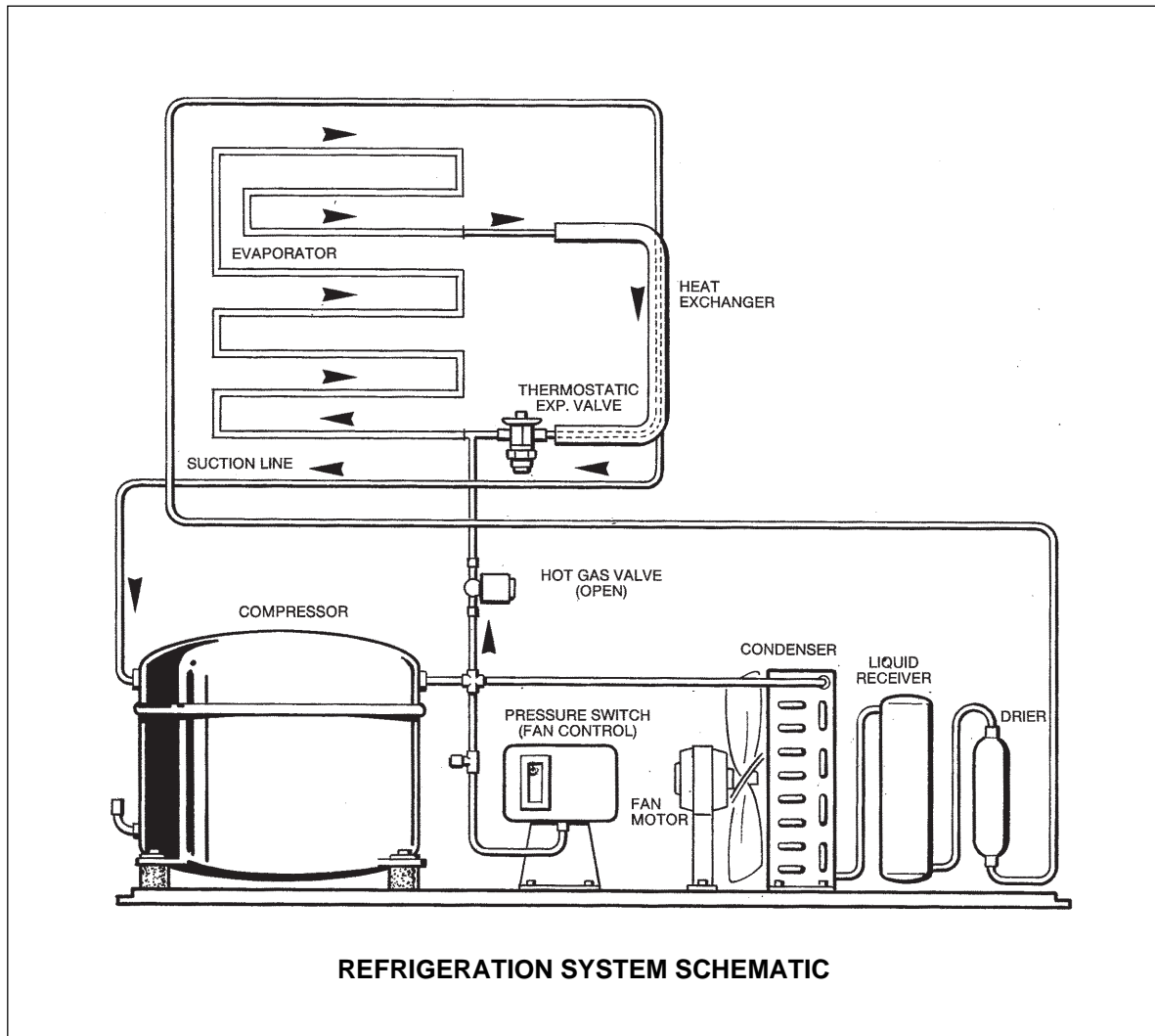

### REFRIGERATION SYSTEM DURING HARVEST

The refrigeration system performs the harvest of ice by use of a hot gas bypass valve. When the time comes to de-ice the evaporators, the hot gas valve is energized, and the high temperature, high pressure gas bypasses the condenser, and is allowed directly into the evaporator. The high pressure gas is cooled by the cold evaporator so it condenses into a liquid, giving up its heat as it does so. This heat warms the evaporator and the ice frozen onto the evaporator surface melts, releasing the frozen cubes. Ice then falls by gravity into the storage bin.

The liquid refrigerant goes through the suction line into the heat exchanger where it boils-off so that only refrigerant vapor is drawn into the suction tube of the compressor.

### WATER SYSTEM

During the harvest cycle, the electric water drain valve is energized thereby opening the drain line.

All water remained in the reservoir at the end of freezing cycle is pumped-out, to the waste, through the water solenoid and drain line during the first 40 seconds of the defrost cycle eliminating any possible build-up and accumulation of minerals concentration and impurities in the water reservoir.

The water inlet valve is energized during the last 10" of the operation of the water pump so to rinse the water tank with new fresh water.

When the released ice cubes drop into the bin, they open-up for a fraction of a seconds the bottom end of plastic deflector.

This deflector swinging motion is enough to reset the contact of the magnetic switch which - via electronic control board - deenergizes the water drain valve allowing the unit to initiate a new freezing cycle.

The harvest cycle lasts about 1.5÷2 minutes.

### CONTROL SEQUENCE

At the start of the freezing cycle, the contacts of the magnetic switch mechanically operated by

the actuator plate of the deflector cover are closed, thereby - via electronic control board - closing the circuit to the main contactor coil and consequently to the compressor and fan motors and 30" later, to the water pump motors.

Then, as the ice thickness reaches the value that corresponds to the full cube size, the film of water that constantly cascades over the slab of ice formed on the evaporator, arrives to establish a contact between the two fingers (energised at low voltage) of the ice sensor control, located on the front upper right side of the evaporator. If the contact between the two fingers of the ice sensor remains established - by the film of water - for more than 10 seconds, a small relay of the electronic board, get energized, controlling - simultaneously both the hot gas valve and the water drain valve.

**NOTE:** in case of failure of ice level sensor, the P.C. Board turns - on automatically the unit into the defrost cycle when the freezing cycle reaches 30 or 40 minutes according to the operation of the fan motor during the freezing cycle.

At this point, the unit initiates the defrost cycle. The hot gas circulating into the evaporator serpentine causes a slight melting of ice cubes which get released from their molds. Once entirely released the ice cubes drop simultaneously into the ice storage bin below; by doing so they move apart from the evaporator bottom end the plastic deflector. This plastic deflector has on its side a magnetic switch that on account of the deflector swinging motion, caused by the ice while dropping in the bin, opens and closes their contacts. This will, in turn, deactivate the relay contacts that controls the hot gas and water drain valve which get deenergized allowing the unit to start a new freezing cycle.

When the ice bin is full of ice, the last batch of ice cubes released from the evaporator accumulates to keep the bottom end of the plastic deflector in open position; with the magnetic switch contacts open for longer than 30" the entire unit stops with the glowing of the corresponding LED.

The machine will restart when the ice deflector will be back in its normal vertical position provided that 3' are elapsed from unit stop. If not the machine will delay its restart till 3' are elapsed with the blinking of the green LED.

**ALARM CONDITIONS**

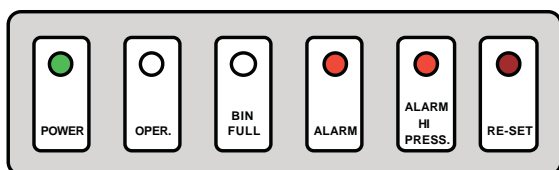

Both the last two Red LED are **ON STEADY: Condenser Sensor OUT OF ORDER.**

Both the last two Red LED are **BLINKING SLOW: WATER ERROR**

Water level inside the water sump too low after 3' from the activation of the Water Inlet Valve.

Both the last two Red LED are **BLINKING FAST: RESET MODE: Charging water through the Water inlet Solenoid Valve after the tripping OFF on WATER ERROR**

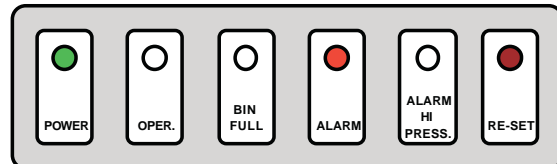

The fourth Red LED is **ON STEADY: Harvest Cycle longer then 3' 30"**

The fourth Red LED is **BLINKING SLOW: TOO HI CONDENSING TEMPERATURE.** The condenser sensor detected a temperature > 65°C

The fourth Red LED is **BLINKING FAST: RESET MODE: Condenser Sensor < 50°C Fan motor in operation for 3' then back on Start Up Cycle Mode**

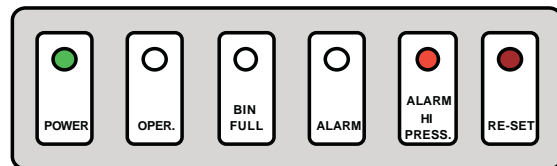

The fifth Red LED is **ON STEADY: TOO HI DISCHARGE PRESSURE > 33 bar 460 PSI**

The fifth Red LED is **BLINKING FAST: RESET MODE: After pushing the Reset Button of the Pressure Control first the fan motor starts up for 3' then back on the Start Up Cycle Mode.**

The PC Board is also checking the maximum time of the freezing cycle that changes according to the operation of the fan motor during the freezing cycle (room temperature):

- Fan motor in **ON-OFF mode:** Max. freezing cycle length equal to 30'
- Fan motor **ON All the time:** Max. freezing cycle length equal to 40'

Whenever the machine remains in the Freezing Cycle for the Maximum time (30 or 40 minutes), the PC Board moves the unit directly into the Harvest Cycle.

## PC BOARD SET UP

The PC Board can be set up for:

- **Manual Reset Mode (Jump IN)**

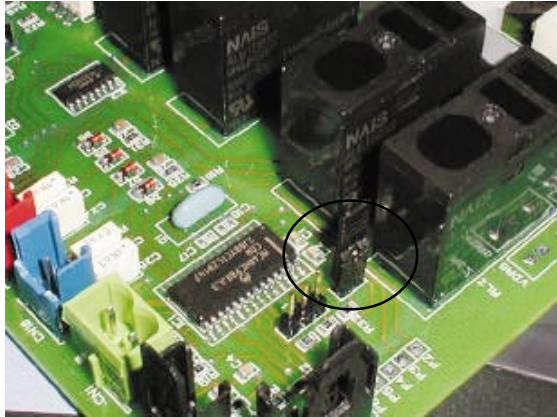

- **Automatic Reset Mode (Jump OUT)**

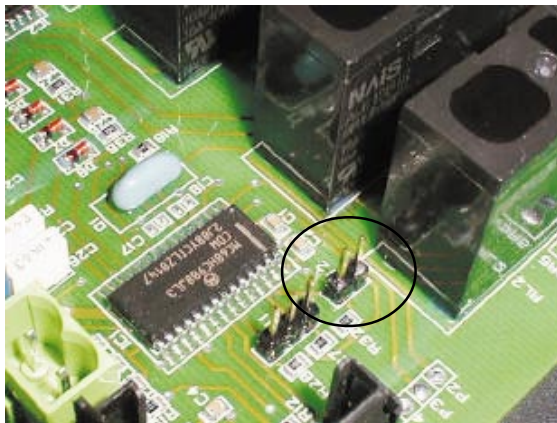

### MANUAL RESET MODE

To **Restart the machine** it is necessary to Push the **RESET BUTTON**



### AUTOMATIC RESET MODE

The **Automatic Reset Mode** is activated only for the following **ALARM CONDITIONS**:

- **WATER ERROR**
- **TOO HIGH CONDENSING TEMPERATURE**
- **TOO LONG HARVEST CYCLE**

#### WATER ERROR

The machine remains in OFF mode for 30' then it tries to re-fill water:

**YES: Machine remains in operation**

**NO: Machine again in OFF mode for additional 30'**

#### TOO HI CONDENSING TEMPERATURE:

As soon as the temperature of the Condenser Sensor is  $< 50^{\circ}\text{C}$ , the PC Board starts up first the fan motor for 3' then the entire machine through the Start-Up Cycle Mode.

#### TOO LONG HARVEST CYCLE:

After the 3' 30" of the Harvest Cycle, the PC Board move back the machine into a new Freezing Cycle.

## SERVICE SPECIFICATION

In servicing a machine, it is often, useful to compare that individual units operating characteristics to those of a normally operating machine. The data that follows gives those characteristics; however, be aware that these values are for NEW, CLEAN machine operating at 21 °C ambient and 15 °C water. USE THESE NUMBERS AS A GUIDELINE ONLY.

### COMPONENT

#### Reservoir level

SV 135-215-315 ..... 80 ÷ 85 mm  
SV 385-535 ..... 100 ÷ 105 mm

**Cube Size Control Ice Sensor** - distance from evaporator ..... 3 ÷ 5 mm

#### High Pressure Safety Switch.

SV 135: Cut IN 19 bar - Cut OUT 30 bar  
SV 215-315-385-535: Cut IN 23 bar - Cut OUT 33 bar

### OPERATING CHARACTERISTICS

On air-cooled models during the freezing cycle, the discharge pressure is maintained between two preset values by means of fan control (condenser sensor); and at the same time, the suction pressure will also decline reaching it's lowest point just before harvest. Compressor amps experience a similar drop.

On water-cooled, the discharge pressure is constantly, maintained during the freeze cycle by the water regulating valve. However, suction pressure and compressor amps, will still decline as the machine freezes ice.

MODEL	Disch. Pressure Freeze max	Disch. Pressure Freeze min	Hi Pressure CUT OUT	Suction Pressure Beginning Freeze	Suction Pressure end Freeze	Freezing time	Amps Compressor Beginning Freeze	Amps Compressor end Freeze
SV 135 A	17,5 bar	14,0 bar	30 bar	4,3 bar	2,3 bar	15'	3,8	3,2
SV 135 W	16,5 bar	16,5 bar	30 bar	4,3 bar	2,4 bar	16'	3,6	3,1
SV 215 A	17,0 bar	15,0 bar	33 bar	3,6 bar	2,3 bar	16'	4,2	3,4
SV 215 W	16,2 bar	16,0 bar	33 bar	3,8 bar	2,5 bar	16'	3,9	3,3
SV 315 A	18,0 bar	16,0 bar	33 bar	2,9 bar	1,7 bar	11'	7,0	5,2
SV 315 W	16,5 bar	16,0 bar	33 bar	2,9 bar	1,7 bar	11'	6,5	5,2
SV 385 A	18,5 bar	15,5 bar	33 bar	2,9 bar	1,5 bar	11' 30"	3,9	3,0
SV 385 W	16,5 bar	16,5 bar	33 bar	2,9 bar	1,7 bar	11' 30"	3,4	2,6
SV 535 A	18,0 bar	15,5 bar	33 bar	3,2 bar	1,7 bar	11' 30"	4,0	3,1
SV 535 W	16,5 bar	16,5 bar	33 bar	3,2 bar	1,9 bar	12'	3,5	2,7

### Refrigerant charge R 404 A

MODEL	SV 135	SV 215	SV 315	SV 385	SV 535
Air cooled 50 Hz	500	700	850	1300	1600
Air cooled 60 Hz	450	600	700	xxxx	1400
Water cooled 50 Hz	400	500	550	1000	1200
Water cooled 60 Hz	400	500	500	xxxx	1000

### Refrigerant metering device

Thermostatic expansion valve.

**NOTE:** Always check nameplate on individual icemachine for special refrigerant charge before charging the refrigeration system. Such refrigerant charge is the average charge for the SV Modular Cubers. However it is important to check nameplate for each machine.

## COMPONENT DESCRIPTION

### 1. Front Console Panel

Equipped with five LED plus a push button that when glow or blink are monitoring:

**LED Nr. 1**

Electrical power supply.

**LED Nr. 2**

Operation.

**LED Nr. 3**

Bin full./Washing.

**LED Nr. 4**

Alarm.

**LED Nr. 5**

Alarm high pressure.

**BUTTON B**

Reset/Washing.

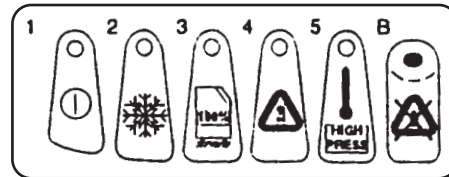

## SV SERIES

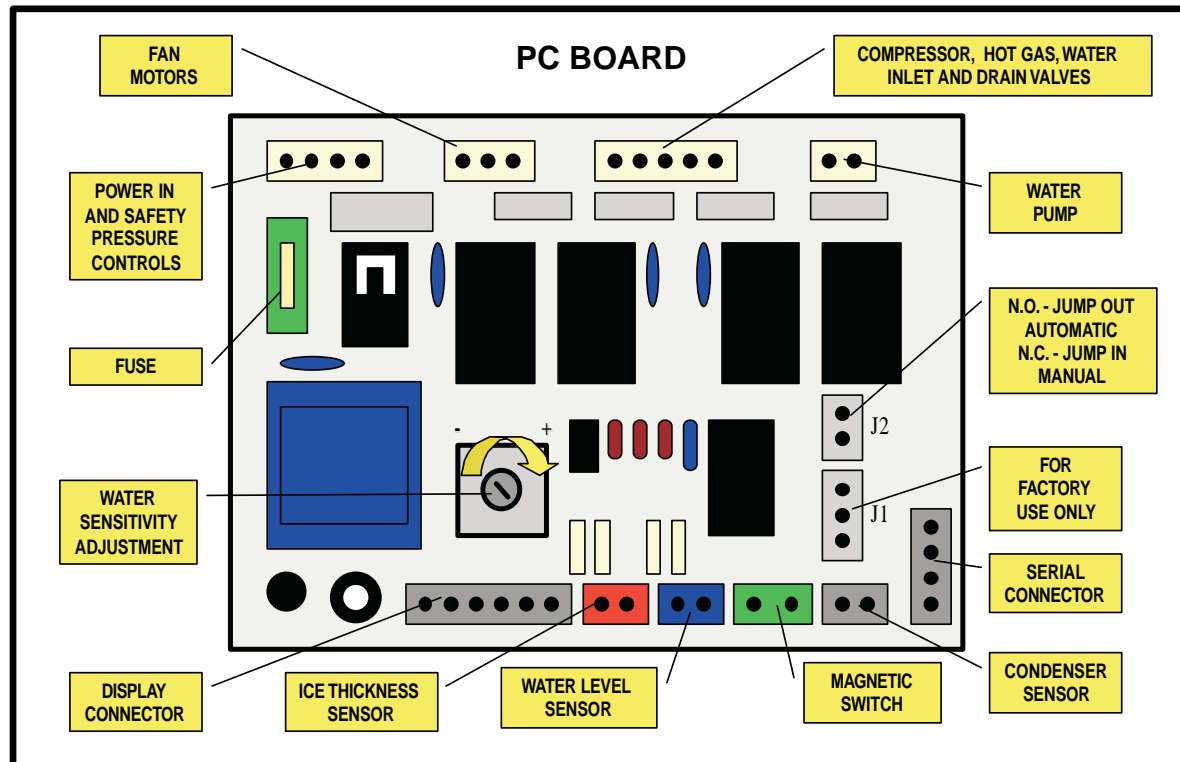

### 2. P.C. Board

Located in the control box, this board is the brain of the system as it governs the ice machine cyclic through sensors, relays and switch. It consists of two separated printed circuits one at high and the other at low voltage integrated with a fuse, of four connectors for the sensors/switches (condenser sensor - BLACK -, magnetic switch - GREEN - ice thickness sensor - RED - water level sensor - BLUE), of two jumpers (one J1 for factory use only - and the second J2 for the selection between manual or automatic reset mode), of one outlet connector (front LED display - black) one serial port connector (black) and of four plug in terminals for input and output power. With J2 closed the P.C. Board is set up for Manual reset mode. When J2 is open on

Automatic Reset mode.

The P.C. Board is equipped by an electronic safety timer that turns-on automatically the unit to defrost cycle when freezing cycle is longer then 30 or 40 minutes and trips-off completely unit when defrost cycle is longer then 3,5 minutes (4th Red LED ON).

A trimmer, located close to the transformer, can change the current received back from the Ice Thickness Sensor according to the Electrical Conductivity of the water.

### 3. Compressor Contactor

Located in the control box, the compressor contactor functions to carry the compressor line current. The contactor is wired to receive power from the P.C. Board.

#### 4. Ice Thickness Sensor

Located in the front upper right side off the evaporator, the sensor is made with two metal reeds in which passes power at low voltage. The two metal reeds, which are individually insulated, are set, through a setting screw, to maintain a minimum clearance from the evaporator (3÷5 mm). Once ice is formed into each mold and is thick enough to fill-up that minimum clearance existing between the two sensor reeds and the evaporator, the water that cascades over the ice has gradually approached to make contact between the two sensor reeds.

It is enough that this contact remains there for about 10 seconds that the P.C. Board receives the signals to put the ice machine on defrost.

#### 5. Magnetic Switch

Located in the front of the evaporator plastic curtain, this switch sends a pulse to the P.C. Board which switches the machine back in the freezing cycle.

#### 6. Hot Gas Solenoid Valve

The Hot Gas Solenoid Valve functions only during the Harvest Cycle, to divert the hot discharge gas from the Compressor, bypassing the Condenser and thermostatic expansion valve, for direct flow to the Evaporator Platen Assembly to release ice cubes from the ice cube molds.

The Hot Gas Solenoid Valve is comprised of two parts, the Body & Plunger and the Coil assemblies. Installed in the discharge line of the Compressor, the energized solenoid coil lifts the valve stem within the valve body to cause the hot discharge gas to be diverted when the ice Thickness sensor has signalled to the P.C. Board to start the Harvest Cycle.

#### 7. Condenser temperature sensor

The condenser temperature sensor probe (located in contact with the condenser tube coil) detects the condenser temperature variations and signals them by supplying current, at low voltage, to the P.C. BOARD.

In the air cooled versions, in relation to the different current received, the micro processor of the P.C. BOARD supplies, through a TRIAC, the power at high voltage to the fan motor so to cool the condenser and to reduce its temperature.

In case the condenser temperature rises and reaches **65°C (150°F)** the current arriving to the micro processor is such to cause an immediate and total stop of the machine operation with the **blinking of the Red LED.**

#### 8. High Pressure Control

The high Pressure Control, a safety control, is factory set to cut-out, at 30 bar and cut-in at 22 bar. The control, functions as a precautionary device to shut OFF electrical power to Icemaker, should a loss of water occur to the water cooled Condenser or a burnt out of the fan motor on air cooled versions. The high Pressure Control is manual reset with reset button located on the

rear side of the machine and a monitoring light on the Front Console Panel.

#### 9. Water Regulating Valve (Water Cooled Models)

The Water Regulating Valve functions maintain a constant Compressor head pressure, by regulating the amount of incoming water flow through the Condenser, on water-cooled models. The valve operate through the refrigerant system high side pressure. Rotating the adjusting screw located on top of the valve, can INCREASE or DECREASE the water flow through the water-cooled Condenser, which in turn, will DECREASE or INCREASE the Compressor operating head pressure.

#### 10. Water Distribution System

The Water Distribution System function to eventy supply water to all cells of the evaporator plate. The water pump pumps water from the sump to the tee. From there water is channeled through the vertical tygon tube to the water distributors, above the evaporator plate, and from the holes in the distributor tube water flows to the cells on one side of the evaporator plate.

Gravity flow returns the unfrozen excess portion of water to the sump reservoir for recirculation.

#### 11. Water Drain Solenoid Valve

The Water Outlet Solenoid Valve functions in conjunction with the water pump to flush-out the sump assembly at the beginning (first 40") of every harvest cycle. This action cleans-up and rinses the sump during each harvest cycle preventing dangerous water minerales concentration.

#### 12. Thermostatic Expansion Valve

The Thermostatic Expansion Valve regulates the flow of refrigerant to the evaporator and reduces pressure of liquid refrigerant from condensing pressure to evaporating pressure.

#### 13. Water pump

The water pump primes the water from the sump to the water distributor tube and through the distributing holes it cascades down onto the evaporator cells by gravity so to be frozen into clear ice cubes. The water pump remains off during the first 30" seconds of the freezing cycle (to avoid any cavitation problem) while it's kept running during the first 40" of defrost/harvest cycle to drain out (purge) the remaining water from the sump (reach in mineral salts).

#### 14. Water inlet solenoid valve - 3/4" male fitting

The Water Inlet Solenoid valve is energised by the P.C. Board during the beginning of the freezing cycle till the water reaches the maximum level into the sump (controlled by the Water Level Sensor).

After 3 minutes, from the start up of the freezing cycle, the Water Inlet Valve is energised again for a short period to re-fill the sump with water till

again to the max. level so to minimise any possibility of slush ice formation  
A flow control, fitted into its outlet port, reduces the pressure of the water flow.

**15. Water level sensor**

The Water Level Sensor, located on the upper right side of the water sump, works in conjunction with the P.C. Board in order to control the water

level at beginning of the freezing cycle by receiving a low power current passing through the water. When the current reaches the PC Board, the water inlet solenoid valve is de-energised. In case the PC Board doesn't receive any signal (current) from the Water Level Sensor within the first 3 minutes of the freezing cycle, the PC Board trips OFF the operation of the machine with the switching ON of the Water Error LEDs.



**SV 135/215/315/385/535 - WIRING DIAGRAM**  
**220 V. 50 Hz. 1 ph.**

m = brown  
 bc = light blue  
 gv = yellow green  
 b = white  
 n = black  
 r = red  
 a = orange

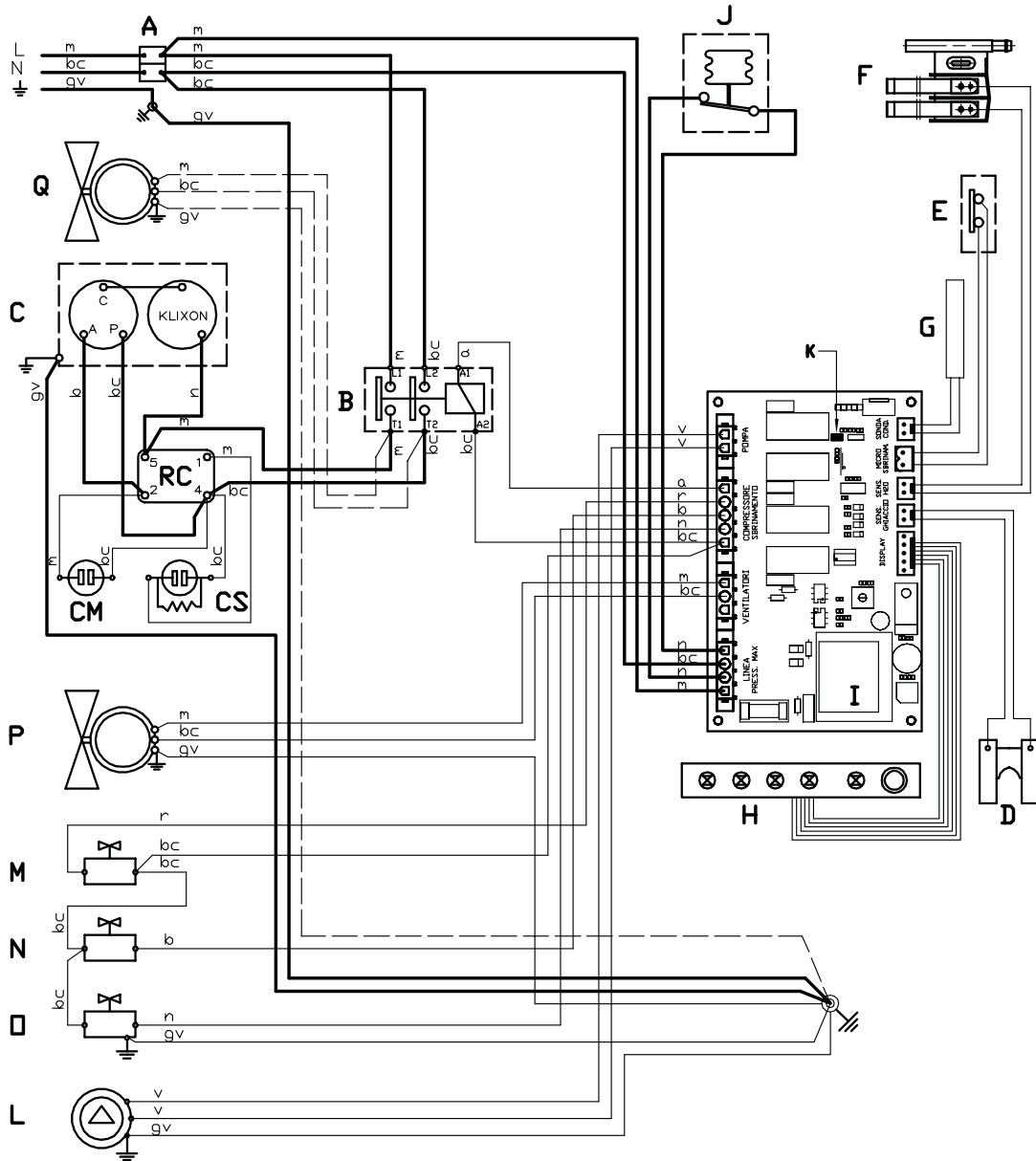

- A - Input terminal board
- B - Compressor contactor
- C - Compressor
- D - Ice sensor
- E - End defrosting switch
- F - Water level sensor
- G - Condenser temperature probe
- H - Led card
- I - PC Board
- J - Hi pressure switch

- K - Manual/Automatic reset jumper
- L - Water pump
- M - Water inlet valve
- N - Water drain/purge valve
- O - Hot gas valve
- P - Fan Motor (only AIR cooled unit)
- Q - Fan Motor (only WATER cooled unit)
- RC - Compressor relay
- CS - Start capacitor
- CM - Run capacitor

### SV 385/535 - WIRING DIAGRAM 400 V. 50 Hz. 3 ph.

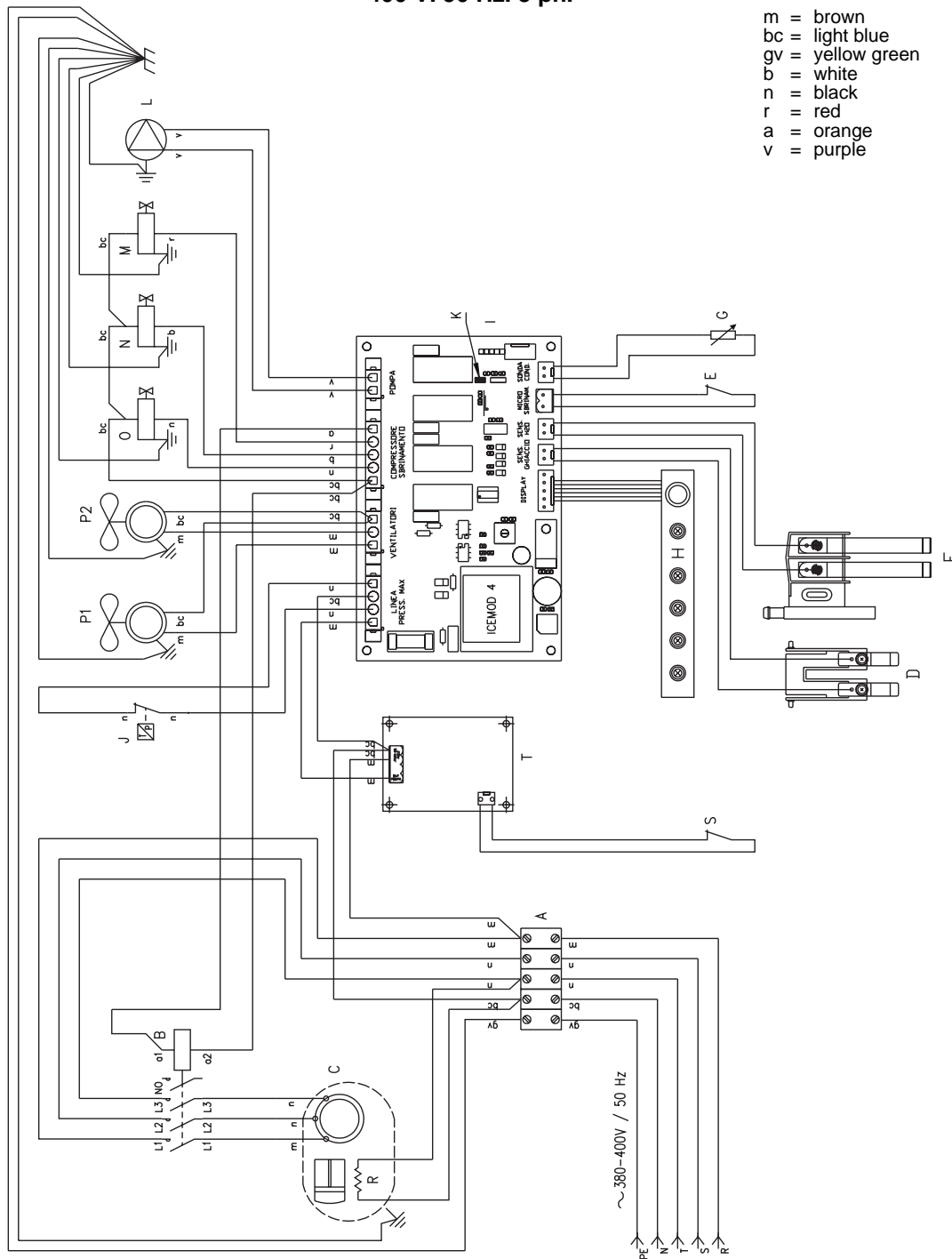

m = brown  
bc = light blue  
gv = yellow green  
b = white  
n = black  
r = red  
a = orange  
v = purple

- A - Input terminal board
- B - Compressor remote control switch
- C - Compressor
- D - Ice sensor
- E - End defrosting switch
- F - Water level sensor
- G - Condenser temperature probe
- H - Led card
- I - Electronic card
- J - Max pressure switch

- K - Automatic reset switch
- L - Water pump
- M - Water inlet valve
- N - Water discharge valve
- O - Hot gas valve
- P1- Fan Motor 1 (only AIR cooled unit)
- P2- Fan Motor 2 (only AIR cooled unit)
- R - Crankcase heater
- S - Delay by pass switch
- T - Start delay electronic board

## SERVICE DIAGNOSIS

The table below is intended as a quick reference to aid the Service Agent in determining the cause of a particular type of malfunction, as well as the recommended repair. It is not intended to be an exclusive list.

Reference to other portions of this manual, including wiring diagrams, installation, and operation are recommended to better determine the cause of a problem.

<b>SYMPTOM</b>	<b>POSSIBLE CAUSE</b>	<b>CORRECTION</b>
Warning Red LED ON No warning LED/LIGHT ON	See page 20 P.C. Board inoperative. No power to unit.	See page 20 Remove board and check. Check electrical source.
Bin full Yellow LED ON	Bin Full of ice. Magnetic switch inoperative.	None. Check and replace.
Machine runs, compressor does not.	P.C. Board compressor relay open. Compressor contactor open. Compressor relay open. Compressor winding open.	Test and replace. Test and replace. Test and replace. Test and replace.
Machine runs, makes ice, does not try to harvest.	Ice thickness control open.  Too soft water.  Built-in relay on P.C. Board open.	Check sensor fingers if are not covered with scale sediment.  Water electrical conductivity must be higher then 20 $\mu$ S. Machine can't run with demineralized water.  Check and replace P.C. Board.
Machine runs, makes and harvests ice but very slowly.	Low refrigerant charge.	Check system for correct refr. charge. Check for leak weight in charge.
Low ice capacity.	High discharge pressure due to not-condensable or overcharge. Inefficient compressor. Condenser dirty. Low water flow (Water-cooled). High air temperature (air-cooled).	Evacuate and weigh in charge.  Replace. Clean. Check and repair.  Check temperature of air entering condenser.
Machine makes irregular ice.	Plugged water distributor. TXV superheat wrong. Refrigerant charge low.	Clean water distributor.  Adjust or replace. Adjust-check for leak. recharge.

## MAINTENANCE & CLEANING & SANITATION INSTRUCTIONS

A SIMAG Ice System represent a sizable investment of time and money in any company's business. In order to receive the best return for that investment, in MUST receive periodic maintenance.

It is the USER'S RESPONSIBILITY to see that preferable, and less costly in the long run, to avoid possible down time by keeping it clean, adjusting it as needed and by replacing worn parts before they can cause failure. The following is a list of recommended maintenance that will help keep your machine running with a minimum of problems.

Maintenance and Cleaning should be scheduled at MINIMUM twice per year while sanitation once per month.

### ICEMAKER

THE FOLLOWING MAINTENANCE SHOULD BE SCHEDULED AT LEAST TWO TIMES PER YEAR ON THIS ICEMAKER. CALL YOUR AUTHORIZED SIMAG SERVICE AGENCY.

1. Check and clean or service any optional water treatment devices, if any installed.
2. Clean water strainer.
3. Check that the cabinet is level, in the side-to-side and front-to-back directions.
4. Clean/Sanitise the water system, evaporator plate and sump assembly, using a solution of Ice Machine Cleaner/Sanitiser. Refer to CLEANING - Ice maker.

**NOTE:** *Cleaning/Sanitising requirements vary according to local water conditions and individual user operation.*

*Continuous check of the clarity of ice cubes and visual inspection of the water system parts, evaporator plates and the sump assembly before and after cleaning will indicate frequency and procedure to be followed in local areas.*

5. Check and tighten all bolts and screws.
6. Check for water leaks and make corrections.
7. Check the bin control to test shut-off. Holding the evaporator deflector in open Position for more that 30", shold cause the ice maker to shut-off. Once the evaporator deflector is released in its closed position, the ice maker will restart.

8. Check cube size, adjust if required through setting screw of ice thickness control sensor.

9. With unit out of operation, clean the condenser using vacuum, cleaner, wisk broom or brush.

Instruct customer to clean condenser frequently DO NOT USE A WIRE BRUSH.

### ICE STORAGE BIN

The interior liner of the bin is in contact with a food product, ice, and should be cleaned and sanitised regularly. Once a week sanitise it with a commercial food grade sanitiser complying with the manufacturer dilution.

### CABINET EXTERIOR

Wipe clean unit and bin cabinet exterior with a clean cloth or disposable paper wipers, soaked in warm water with mild detergent solution.

### CLEANING - Ice maker

**WARNING - Ice Machine Cleaner contains Phosphoric and Hydroxyacetic acids. These compounds are corrosive and may cause burns. If swallowed, DO NOT induce vomiting. Give large amounts of water or milk. Call physician immediately. In case of sxternal contact, flush with water. KEEP OUT OF THE REACH OF CHILDREN.**

1. Empty bin of ice.
2. Remove front panel.
3. Wait till the end of the defrost/harvest cycle then push the RESET BUTTON for 6-8 seconds. The machine should stop with the blinking of the Yellow LED (slow blink).
4. Pour on SV 135 150 cc and on SV 215-315-385-535 250 cc of Simag Ice Machine Clea-ner directly into the reservoir then push again the **RESET BUTTON** for a while. The water pump starts to operate with the fast blinking of the Yellow LED while the water inlet valve will be energized till the fill up of the water sump.
5. After 15 minutes push the RESET BUTTON for a while. The P.C. Board put the machine in automatic rinsing mode with the special blinking (blink twice and repeat) of the Yellow LED.

**NOTE:** *RINSING mode consists of:*

- a) energize the water drain valve and the water pump for 40 seconds to empty the reservoir*
  - b) deenergize the water drain valve and the water pump for 1 minute*
  - c) energize the water inlet valve till the fill up of the water sump*
  - d) energize the water pump for 1,5 minutes.*
- The above sequence is repeated 7 times so to be sure to have removed any possible trace of Ice Machine Cleaner.*

6. At the end of the 7th Rinsing cycle the P.C. Board stops the operation of the machine with the blinking (slow) of the Yellow LED.

7. Pushing the RESET BUTTON for 6-8 seconds the machine restarts in the freezing cycle.

8. Replace the evaporator cover deflector and front panel.

9. Check the next batch of cubes to be sure all the cleaner is gone (no sour taste).

**CAUTION - DO NOT use ice cubes produced from the cleaning solution. Be sure none remains in the bin.**

10. Pour hot water into the storage bin melt the cubes, and to also clean the bin drain.

# SIMAG

ICE MACHINES

[www.simag.it](http://www.simag.it)

SIMAG  
via Risorgimento, 4  
20017 Mazzo di Rho (MI) - Italy  
Tel. +39 02 93900215 (Commerciale - Sales Dept.)  
Tel. +39 02 93960357 (Assistenza - Service Dept.)  
Fax +39 02 93900226 (Commerciale - Sales Dept.)  
Fax +39 02 93960366 (Assistenza - Service Dept.)  
e-mail: [sales@simag.it](mailto:sales@simag.it)  
e-mail: [service@simag.it](mailto:service@simag.it)

Singapore Office  
SIMAG FAR EAST  
627A Aljunied Road  
04-04 Biztech Centre  
Singapore 389842  
Tel. ++65 6738 5393  
Fax ++65 6738 1959  
e-mail: [scotsice@singnet.com.sg](mailto:scotsice@singnet.com.sg)



Certified ISO 9001  
TOTAL QUALITY

